

# HULALA

---

## H O M E

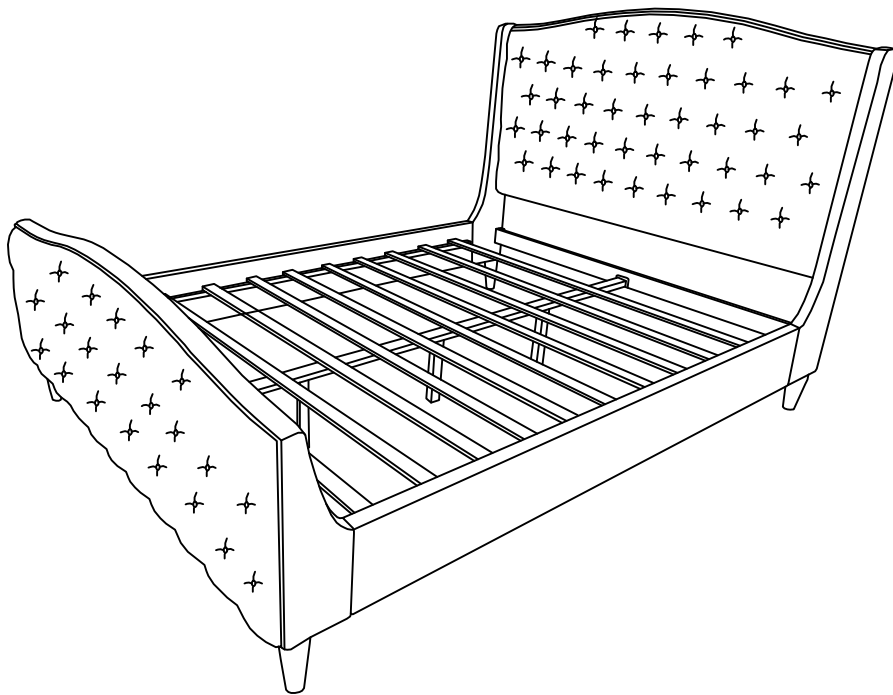

**ITEM NO.BDAS0743-QB**

---

### NOTE:

This brochure contains IMPORTANT safty info. Please read and keep for future reference.

---



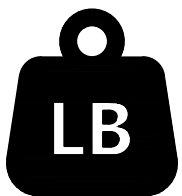

# MAINTAINANCE AND WARNING

- 1.Keep furniture away from heat sources.
- 2.Do not clean furniture with harsh cleaner or polishes.Do not use detergents,solvents,abrasives,spray packs or leather cleaner. Use non-color mild soa with warm water to clean spills(Mix 1:10 soap to water).
- 3.Do not place furniture under direct sunlight,material will possibly fade over time.
- 4.Do not use on site dry cleaning machine.Children should not climb or jump on the furniture.
- 5.Do not write on furniture that is not protectedby a padded barrier.
- 6.Not for commercial use,only for residential use.



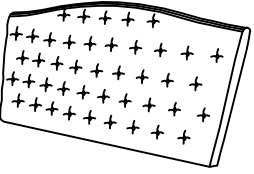
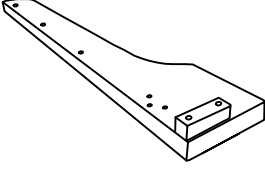
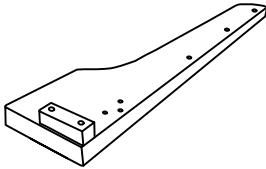
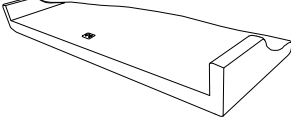
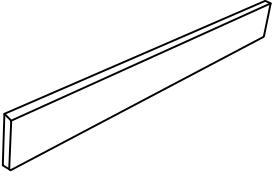

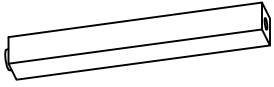
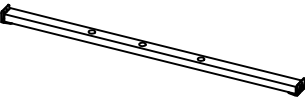
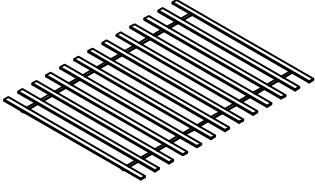

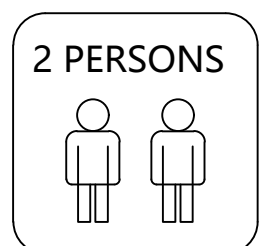

Weight Limitation  
**700 LBS**

# PARTS LIST

A	x1	B	x1	C	x1	D	x1
							
Headboard		Headboard wing right		Headboard wing left		Footboard	
E	x1	F	x1	G	x1	H	x3
							
Side rail right		Side rail left		Headboard support rail		Support leg	
I	x1	J	x1	K	x4		
							
Support rail		Slats		Leg			



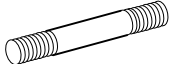
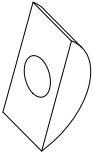

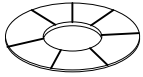
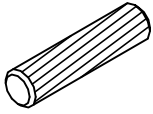

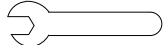

# HARDWARE LIST

L	x8	M	x11	N	x16	O	x3	P	x8	Q	x8
											
Bolt		Flat washer		Spring washer		Bolt		Bolt		Curved washer	
R	x8	S	x20	T	x4	U	x4				
											
Nut		Screw		Plastic washer		Wooden dowel					

# TOOL LIST

V	x1	W	x1
			
Allen key		Wrench	

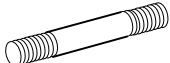
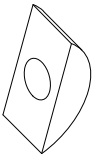
# HARDWARE SPARE LIST

L	x1	M	x1	N	x1	O	x1	P	x1	Q	x1
											
Bolt		Flat washer		Spring washer		Bolt		Bolt		Curved washer	
R	x1	S	x1								
											
Nut		Screw									

# ASSEMBLY INSTRUCTIONS

## STEP-1

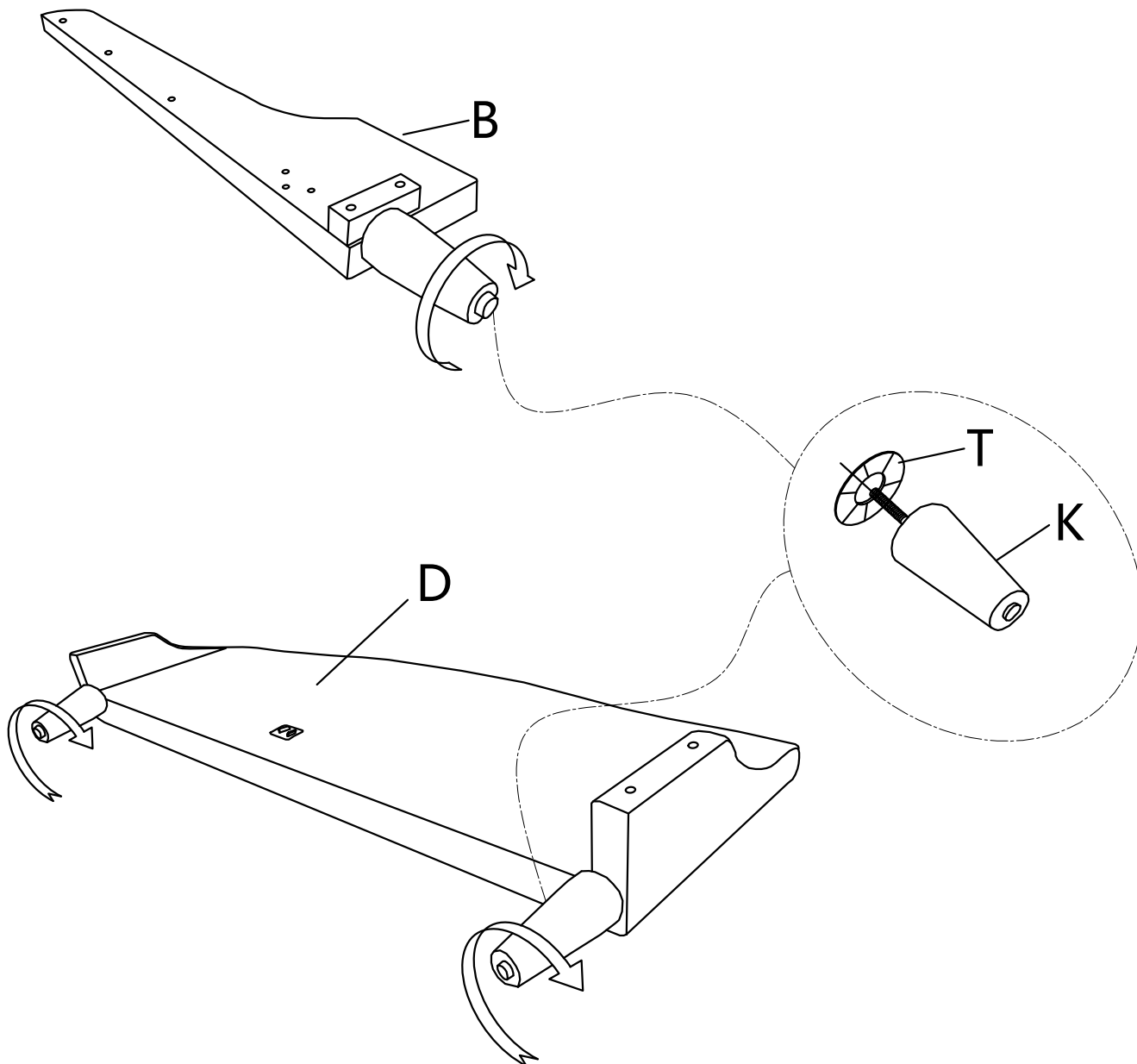

**Step 1:** Through the plastic washer (T), screw the wood leg (K) to the footboard (D) and headboard wing right (B), left (C).

# ASSEMBLY INSTRUCTIONS

## STEP-2

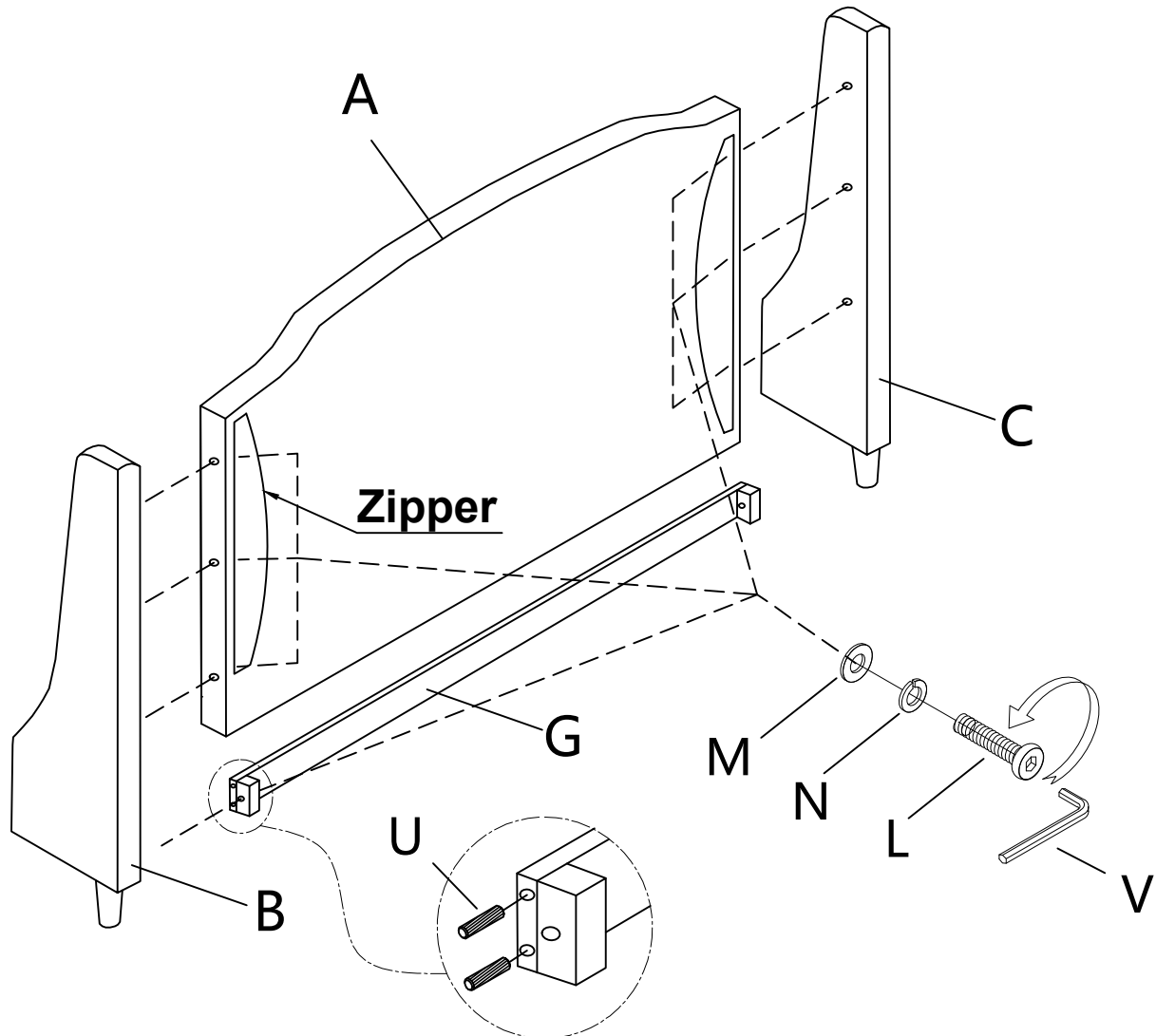

**Step 2:** Unzipping from the back of headboard, install headboard wing right (B), left (C) to the headboard (A) and headboard support rail (G) with Bolt (L), spring washer (N) and flat washer (M). Tighten them by Allen Key (V).

# ASSEMBLY INSTRUCTIONS

## STEP-3

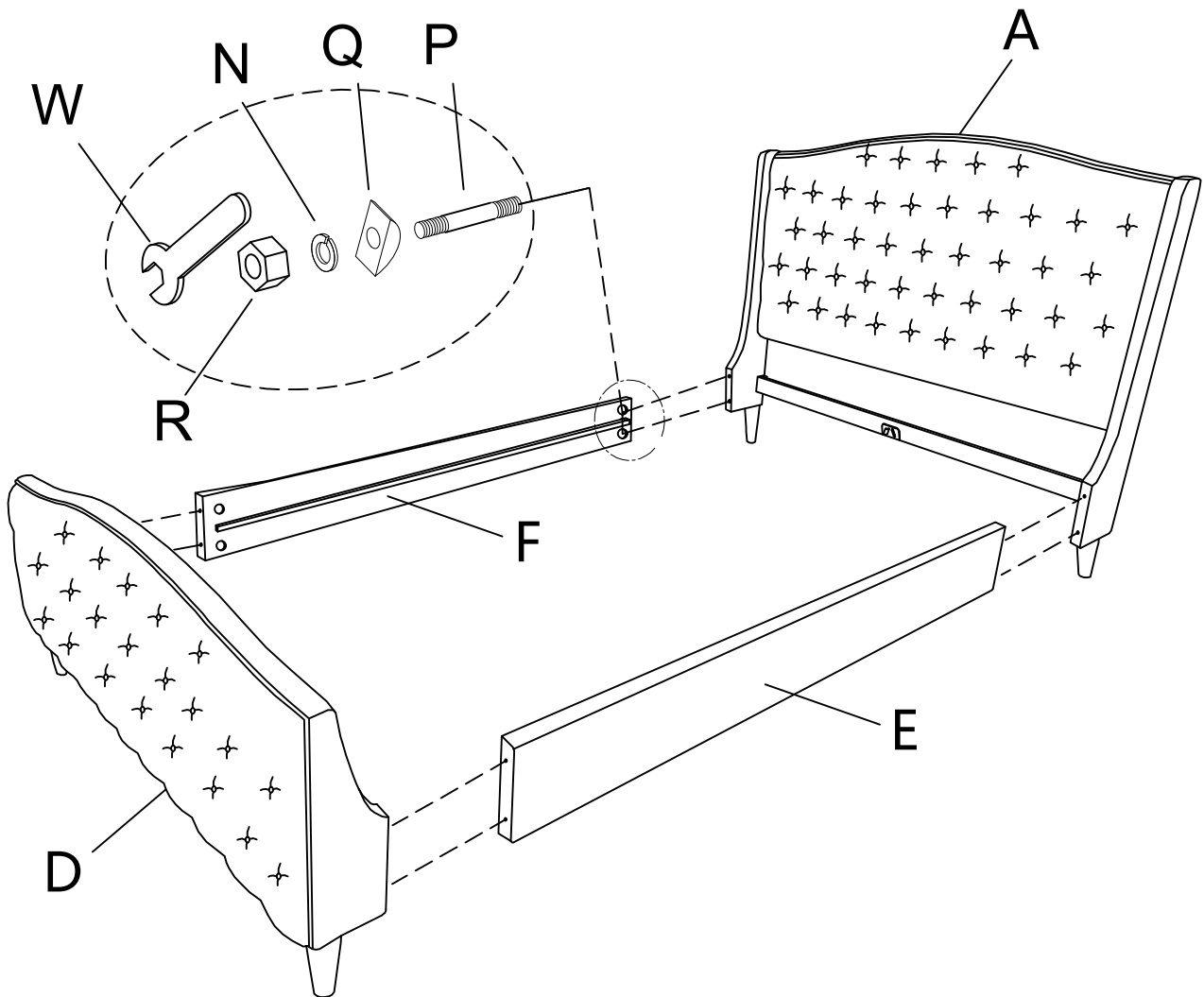

**Step 3:** Assemble the side rail (E),(F) to the headboard(A) and footboard (D) with bolt (P), curved washer (Q), spring washer (N) and nut (R). Tight them by wrench (W).

# ASSEMBLY INSTRUCTIONS

## STEP-4

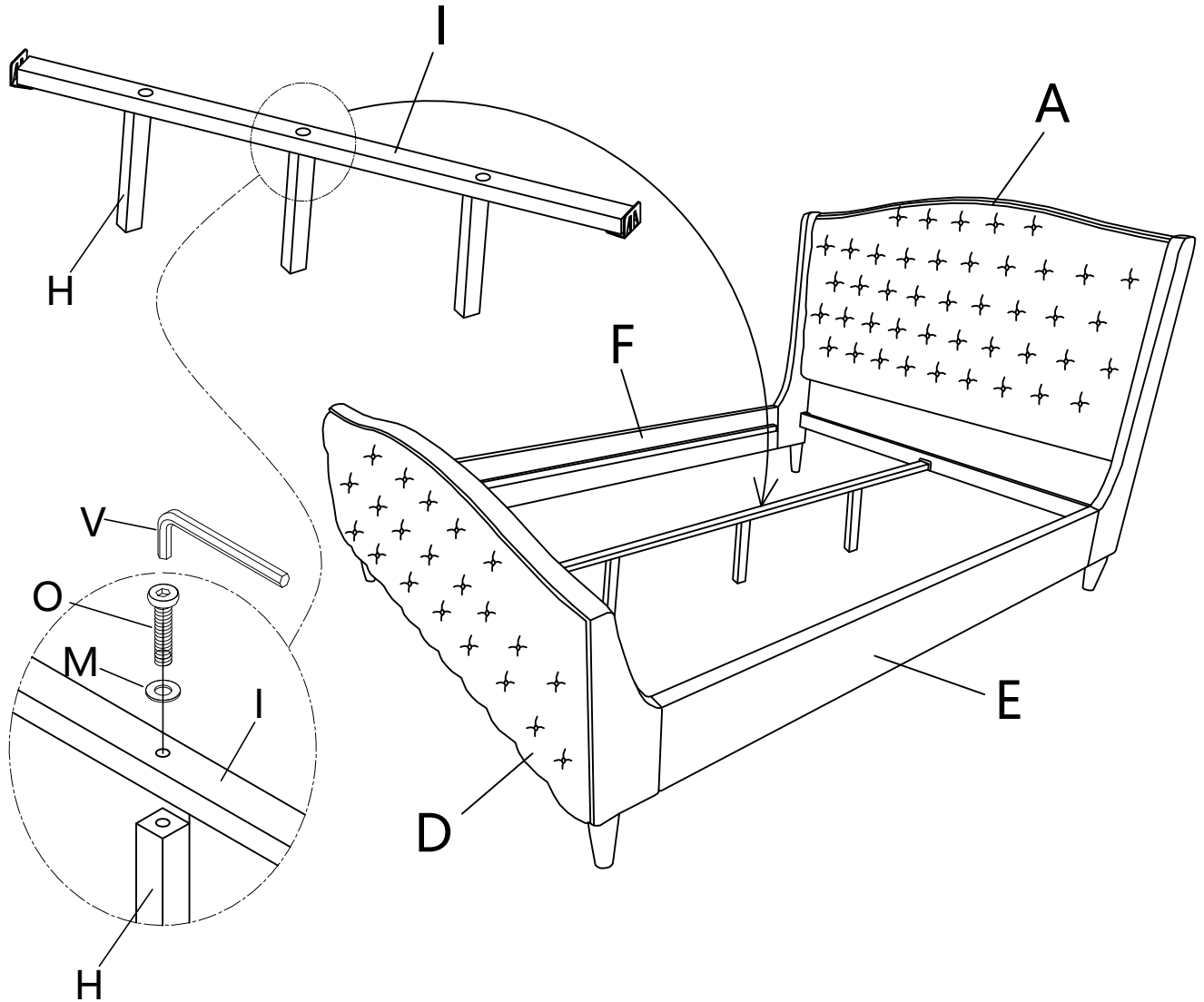

**Step 4:** Install support leg (H) to the support rail (I) with bolts (O) and flat washer (M). Tighten them by Allen Key (V). Assemble support rail (I) to the headboard(A) and footboard (D).



# ASSEMBLY INSTRUCTIONS

## STEP-5

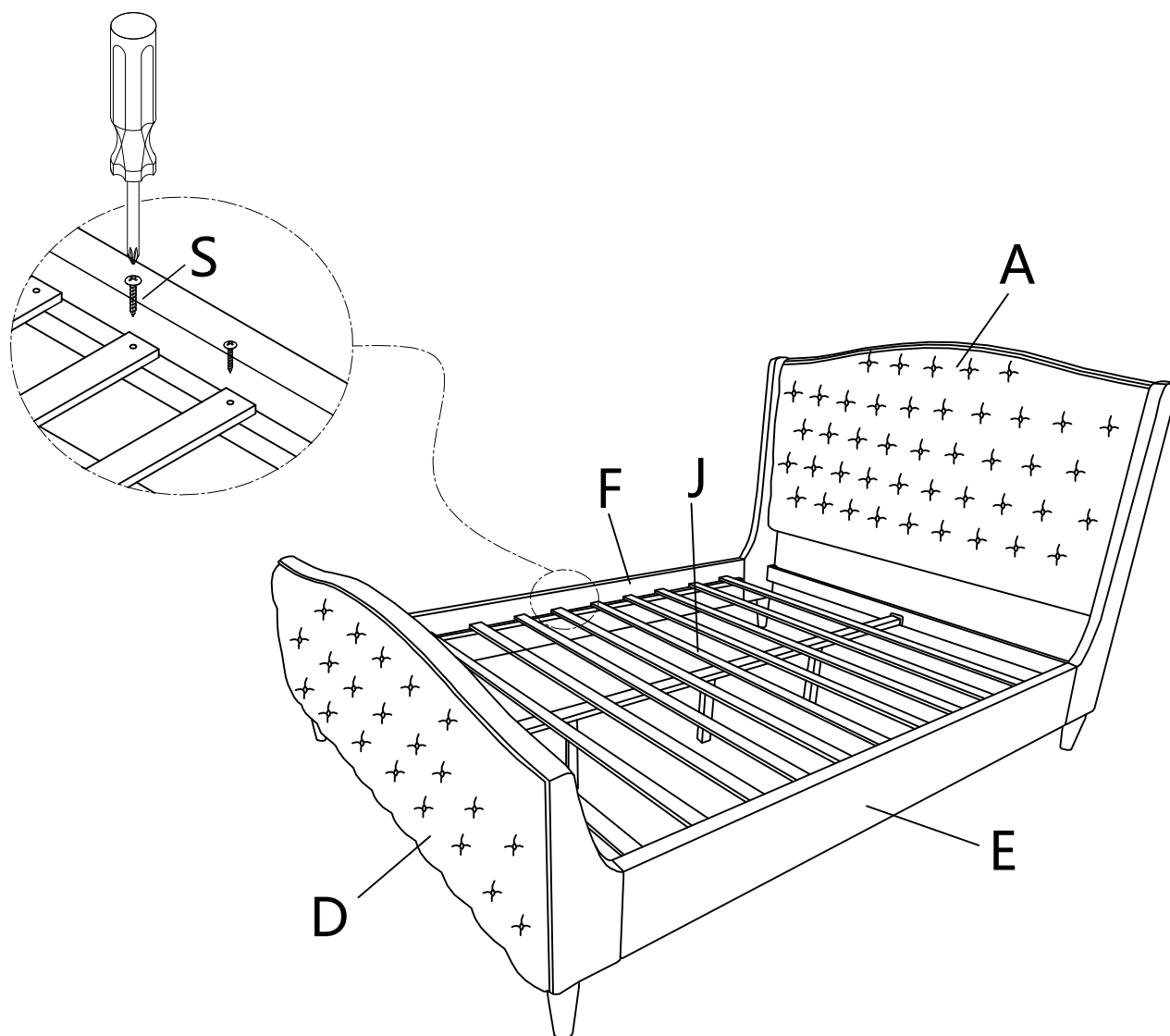

**Step 5:** Assemble slats (J) and screw (S) the slats (J) to the side rail (E),(F) using screwdriver (not provided).

# ASSEMBLY INSTRUCTIONS

## STEP-6

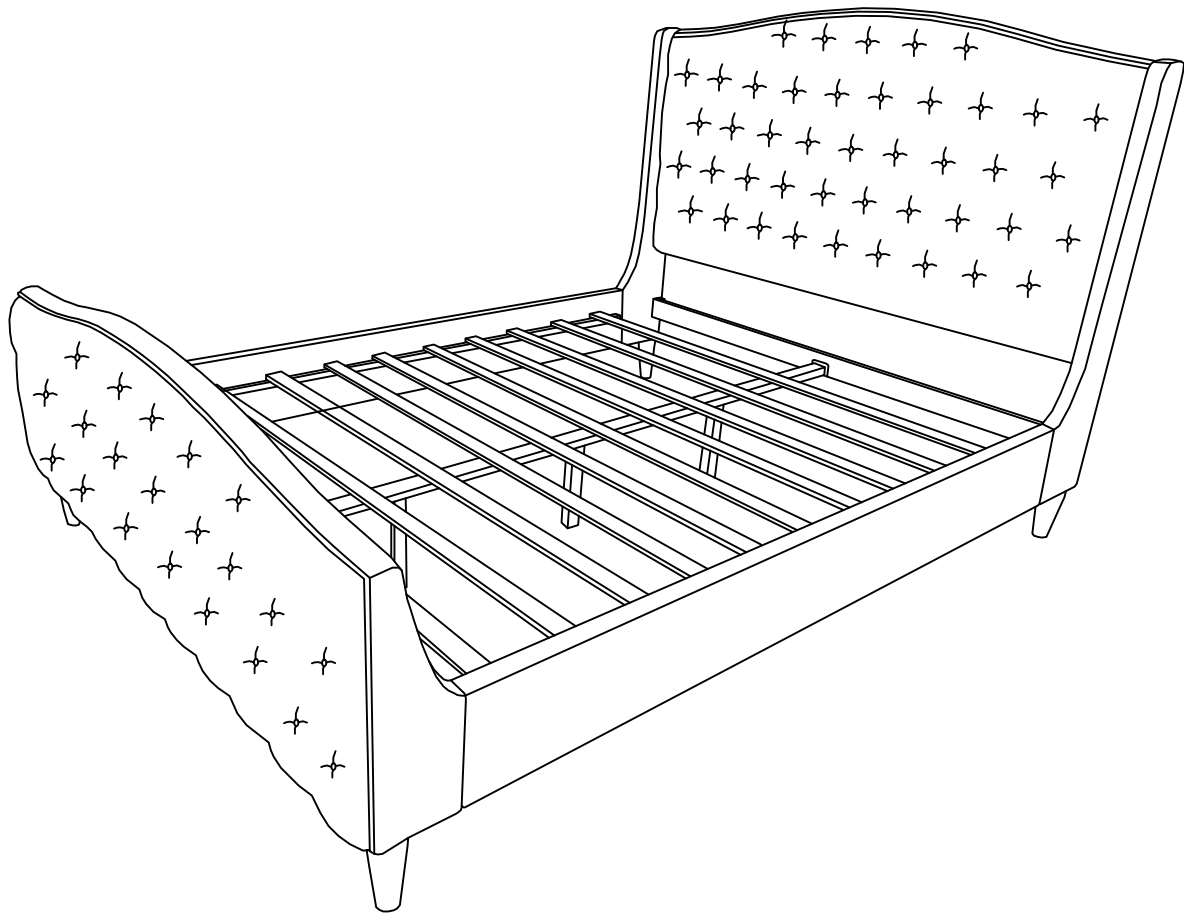

**Step 6:** Assembly complete.

# WARRANTY

1. We strive to offer high-quality products, and we also try our best to satisfy each and every customer that orders from us with product or service as needed.
2. We provide 30 days warranty starting from the time you receive the item. Each customer must provide a record of their order such as the order number, or item receipt for any items that are out of the warranty period you may also still receive.
3. Replacement parts by purchasing them with our company if they are available.

Are you having difficulty  
With assembly? Missing parts?  
Please send email with your order No to  
**[customerservice@hulalahome.com](mailto:customerservice@hulalahome.com)**  
For return, please check the return policy with  
the retailer or market place you bought from.

Appreciate your purchasing from us.  
Pop up your life by our furniture piece!