

WARRANTY

We strive to offer high-quality products, and we also try our best to satisfy each and every customer that orders from us with product or service as needed. We provide 30 days warranty starting from the time you receive the item. Each customer must provide a record of their order such as the order number, or item receipt for any items that are out of the warranty period you may also still receive replacement parts by purchasing them with our company if they are available.

**Are you having difficulty
with assembly? Missing parts?**

**Please send email with your order No to
customerservice@hulalahome.com**

**For return, please check the return policy with
the retailer or market place you bought from.**

**Appreciate your purchasing from us.
Pop up your life by our furniture piece!**

HULALA
H O M E

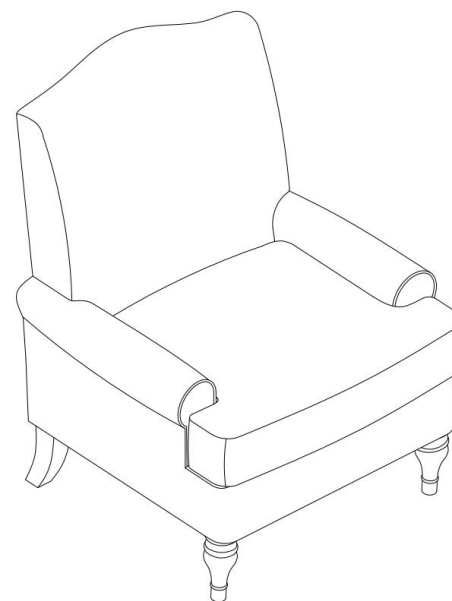

ITEM NO. CHM0605/CHM0606

NOTE:

This brochure contains IMPORTANT safty info. Please read and keep for future reference.

MAINTAINANCE AND WARNING

- Keep furniture away from heat.
- Do not clean furniture with harsh cleansers or polish. Do not use detergents, Solvents, abrasives, spray packs or leather cleaner. Use non-color mild soap with warm water clean spills(Mix 1:10 soap to water)
- Do not place furniture under direct sunlight, material will possibly fade over time.
- Do not use on site dry Cleaning machine.
- Children should not climb or jump on the furniture.
- Do not write on furniture without a padded barrier to protect the surface.
- Not for commercial use, For residential use only.



Weight Limitation

250LBS

PARTS LIST

A*1

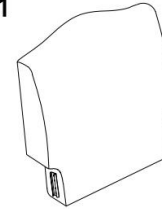

Back

B*1

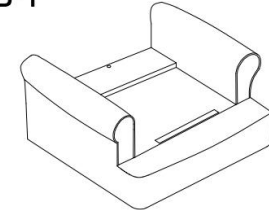

Seat Frame

C*1

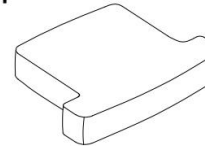

Seat Cushion

D*2



Front Legs

E*2



Back Legs

Persons Required For Assembly:



HARDWARE LIST

①*8
M6*20mm



Bolt

②*1
M8*80mm



Bolt

③*1



Nut

④*2



Flat washer

⑤*1



Allen Key

SPARE

①*1
M6*20mm



Bolt

②*1
M8*80mm



Bolt

③*1



Flat washer

Be sure to check all packing material carefully for small parts, which may have come loose inside the carton during shipment.

ASSEMBLY INSTRUCTIONS

STEP 1

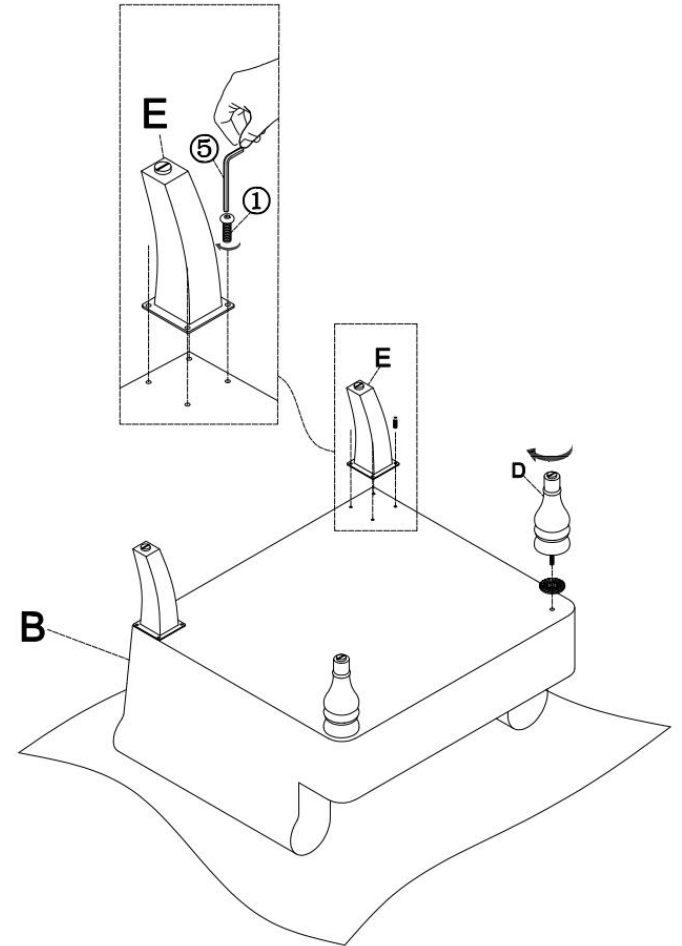

STEP 2

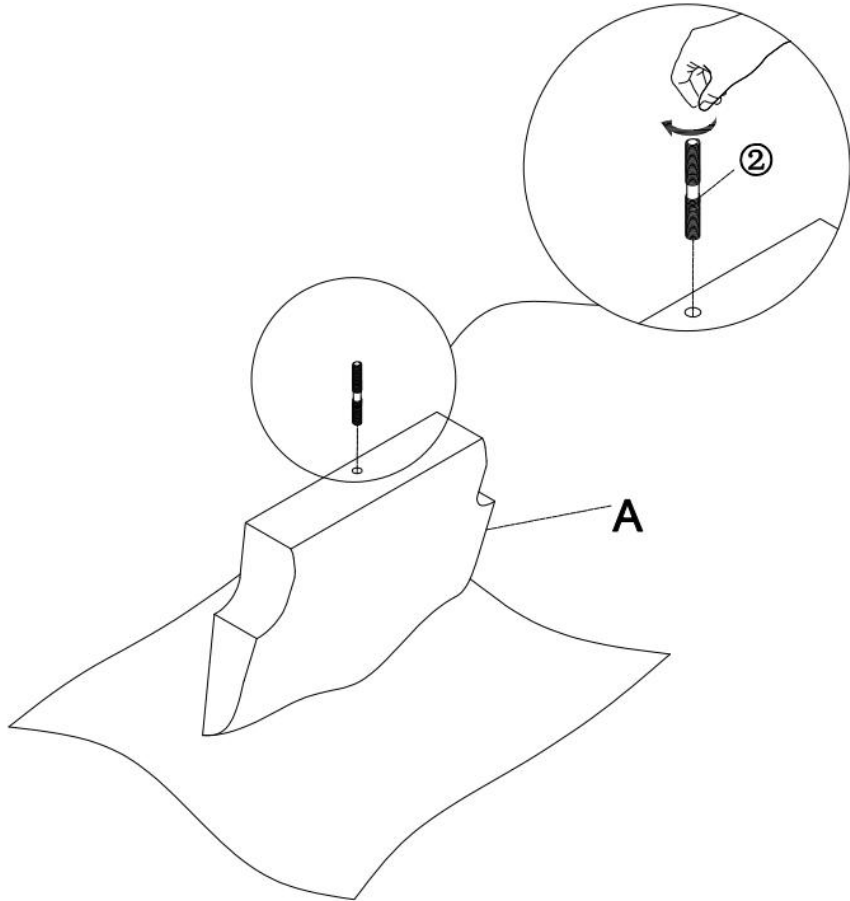

STEP 3

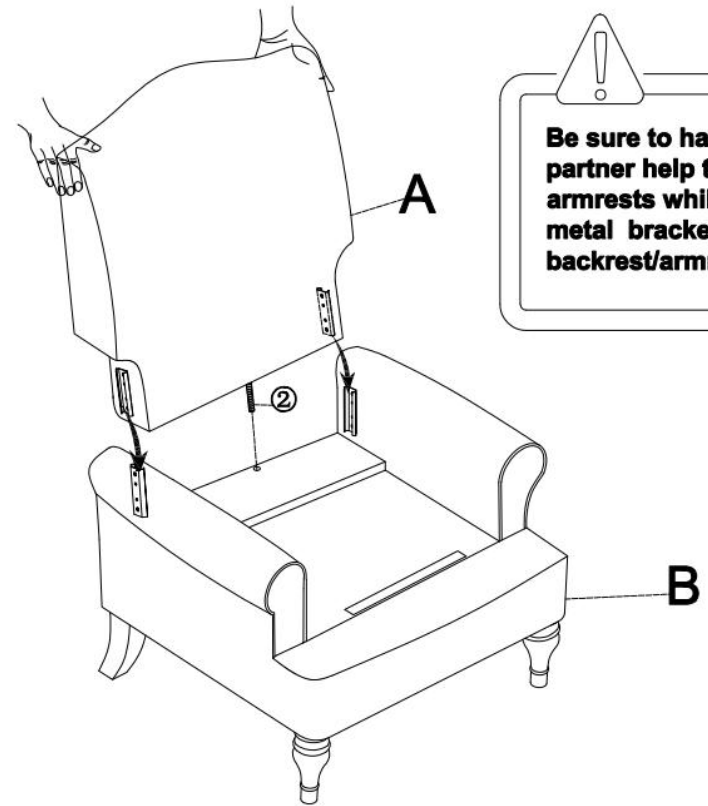

STEP 4

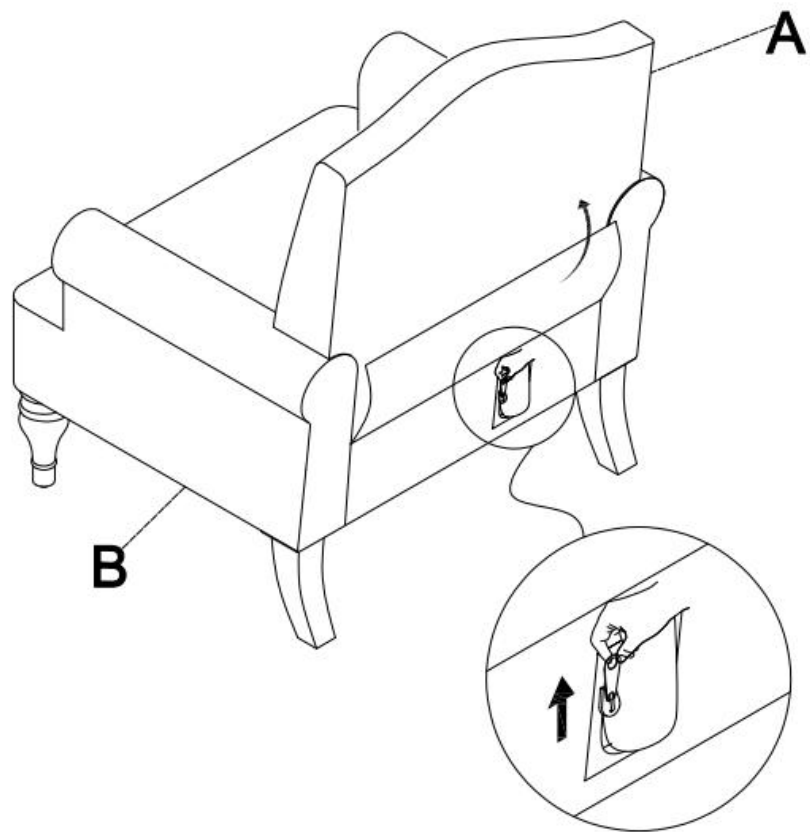

STEP 5

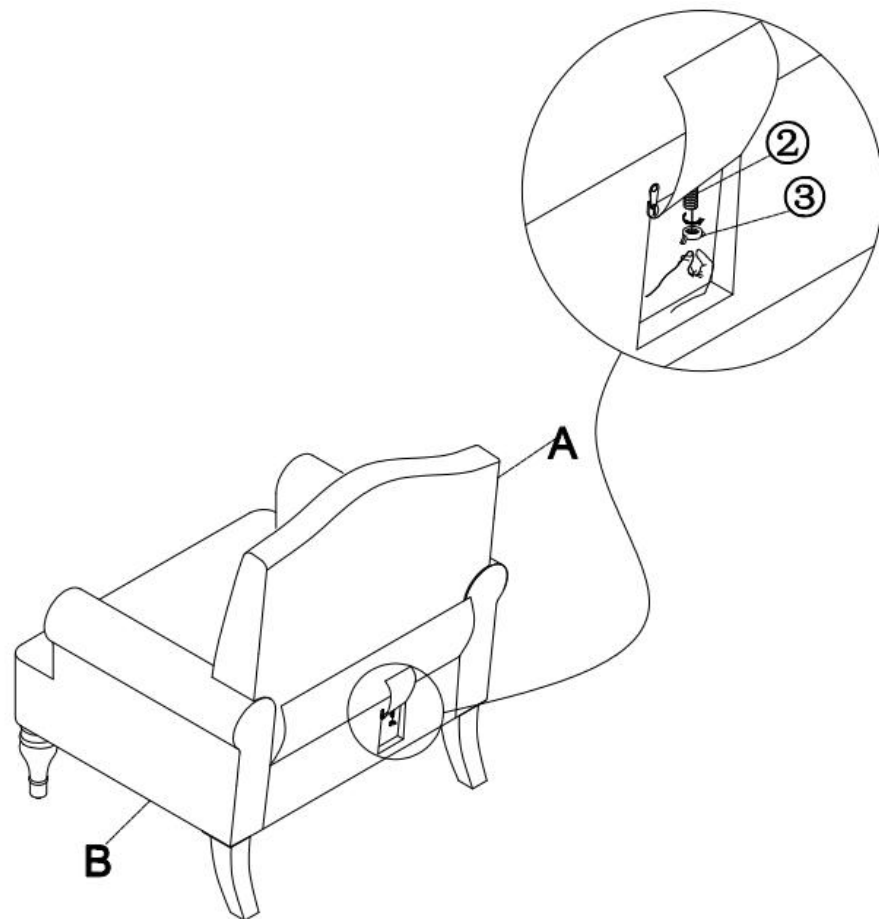

STEP 6

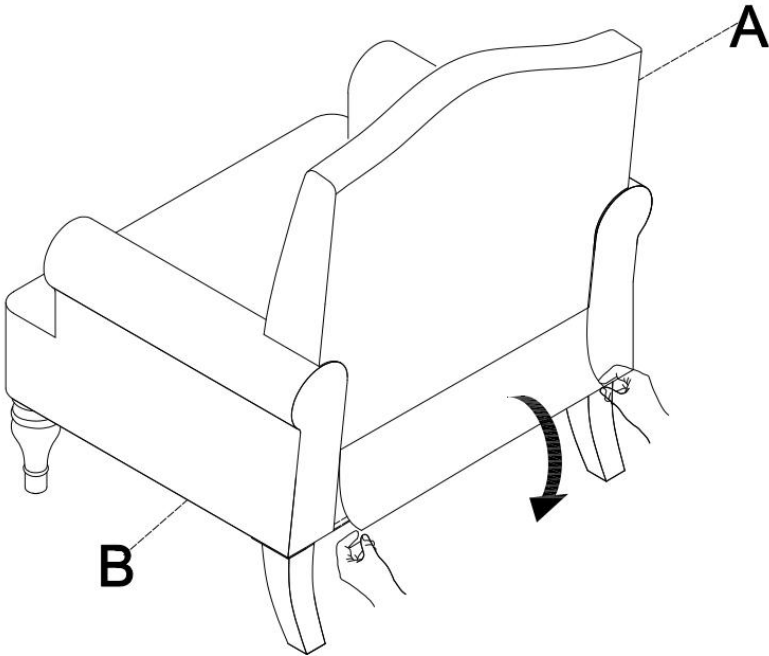

STEP 7

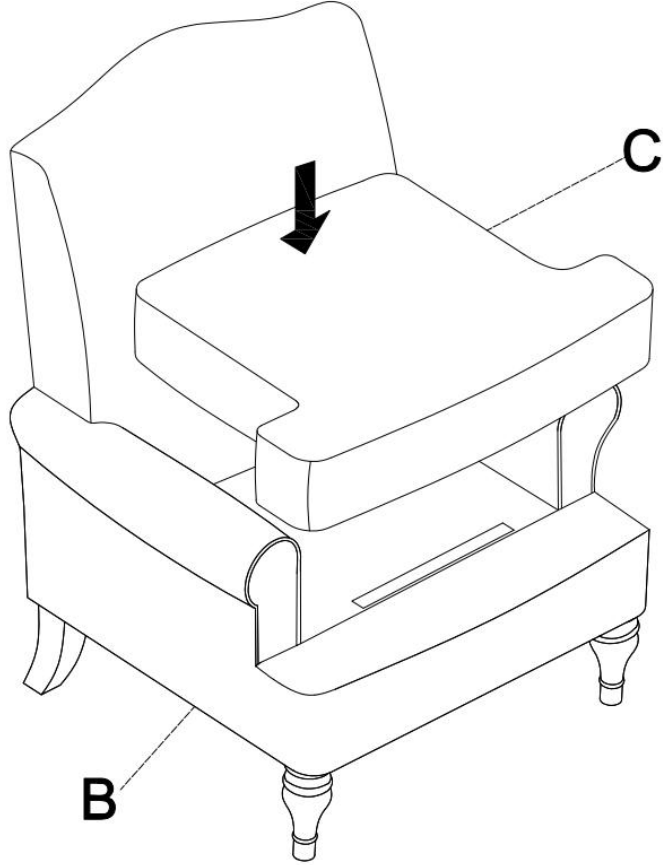

STEP 8



Attention:
After installation, adjust the adjustable leveler to keep the chair balanced .
Be sure to check all packing material carefully for small parts, which may have come loose inside the carton during shipment.

