

HULALA

H O M E

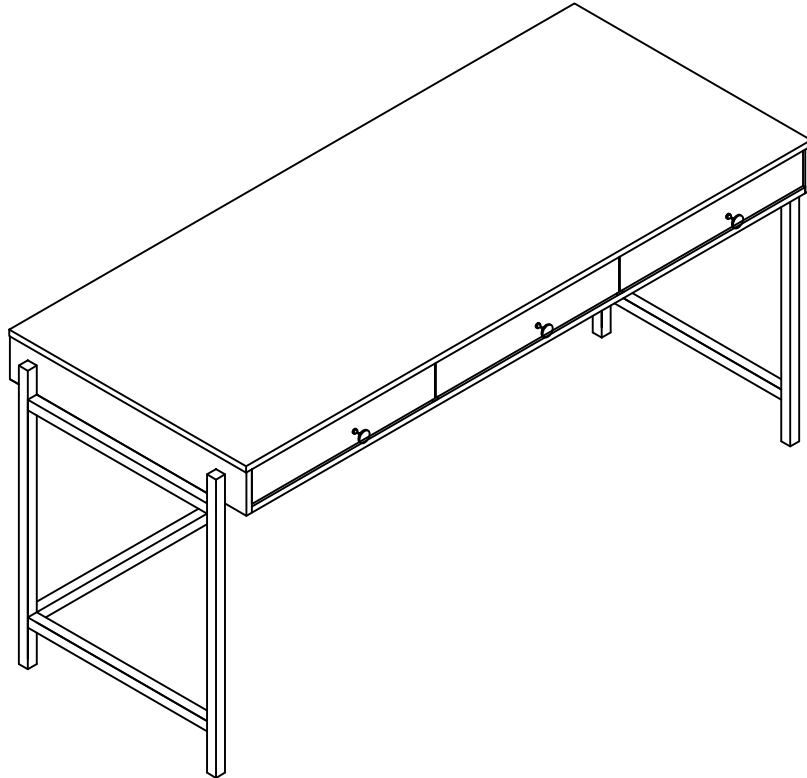

ITEM NO. DKHN0067-1

NOTE:

This brochure contains IMPORTANT safety info. Please read and keep for future reference.

WARRANTY

We strive to offer high-quality products, and we also try our best to satisfy each and every customer that orders from us with product or service as needed. We provide 30 days warranty starting from the time you receive the item. Each customer must provide a record of their order such as the order number, or item receipt for any items that are out of the warranty period you may also still receive replacement parts by purchasing them with our company if they are available.

**Are you having difficulty
with assembly? Missing parts?**

**Please send email with your order No
customerservice@hulalahome.com**

**For return, Please check the return policy with
the retailer or MarketPlace you bought from.**

**Appreciated your purchasing from us.
Pop up your life by our furniture piece!**

MAINTAINANCE AND WARNING

- Keep furniture away from heat.
- Do not clean furniture with harsh cleansers or polish. Do not use detergents, Solvents, abrasives, spray packs or leather cleaner. Use non-color mild soap with warm water clean spills(Mix 1:10 soap to water)
- Do not place furniture under direct sunlight, material will possibly fade over time.
- Do not use on site dry Cleaning machine.
- Children should not climb or jump on the furniture.
- Do not write on furniture without a padded barrier to protect the surface.
- Not for commercial use, For residential use only.

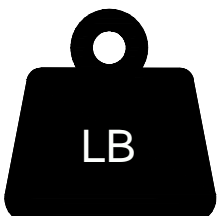

Weight Limitation





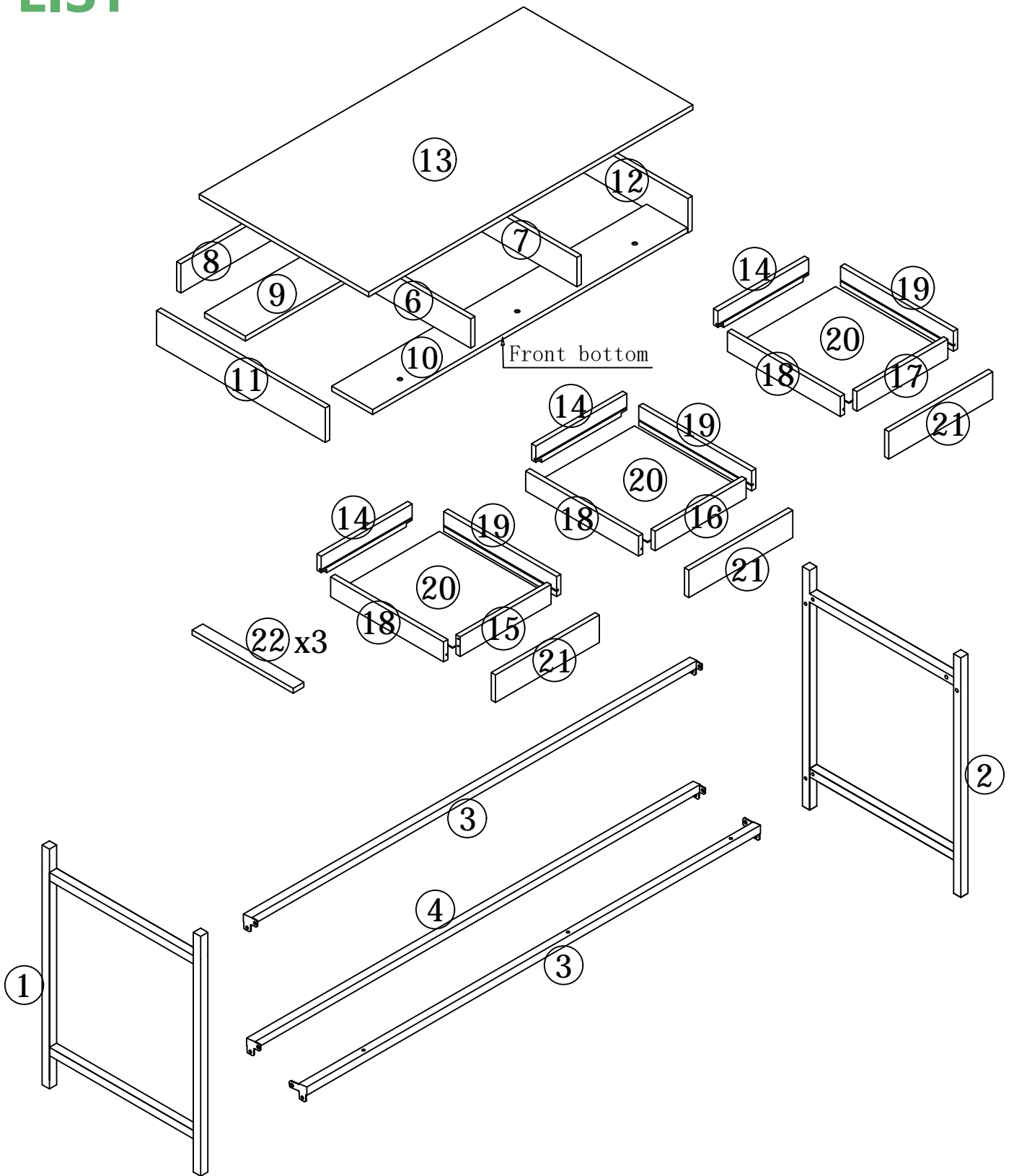







275LBS

PARTS LIST



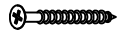







Check all parts according to parts and hardware list make sure all parts present before assembly as some small parts may come loose during transit. Place all parts on clean padded surface and line up according to sequence of assembly.

HARDWARE LIST

A M6x15  12pcs	B 4mm  1pc	C M6x35  6pcs	D  3pcs	E 1/4*38  3pcs	F 15*12  42pcs
G 7*36  42pcs	H 8*30  8pcs	I 3.5*14  24pcs	J 4*40  12pcs	K 16"  3pcs	L M6*25  6pcs
M  6pcs					

SPARE EXTRA PARTS

A M6x15  1pc	C M6x35  1pc	F 15*12  1pc	G 7*36  1pc	H 8*30  1pc	I 3.5*14  3pcs
J 4*40  1pc	L M6*25  1pc	M  1pc			

Be sure to check all packing material carefully for small parts, which may have come loose inside the carton during shipment.

ASSEMBLY INSTRUCTIONS

open and place all parts on a clean, no-marring surface.

STEP 1:

Ax12

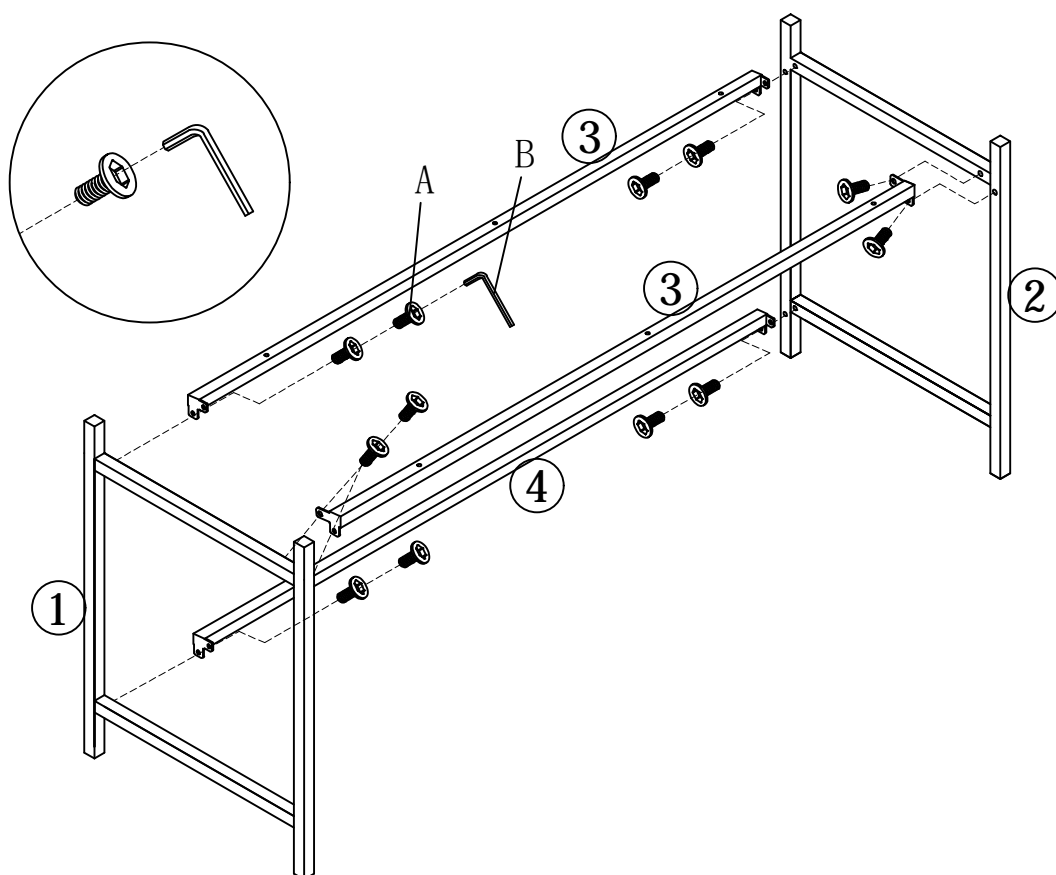

Use bolt A and allen Key B to connect stretchers 3 and 4 with side frames 1&2. Make sure all parts sets leveled then fasten all bolts to secure.

ASSEMBLY INSTRUCTIONS

STEP 2:

Ix24

Kx3

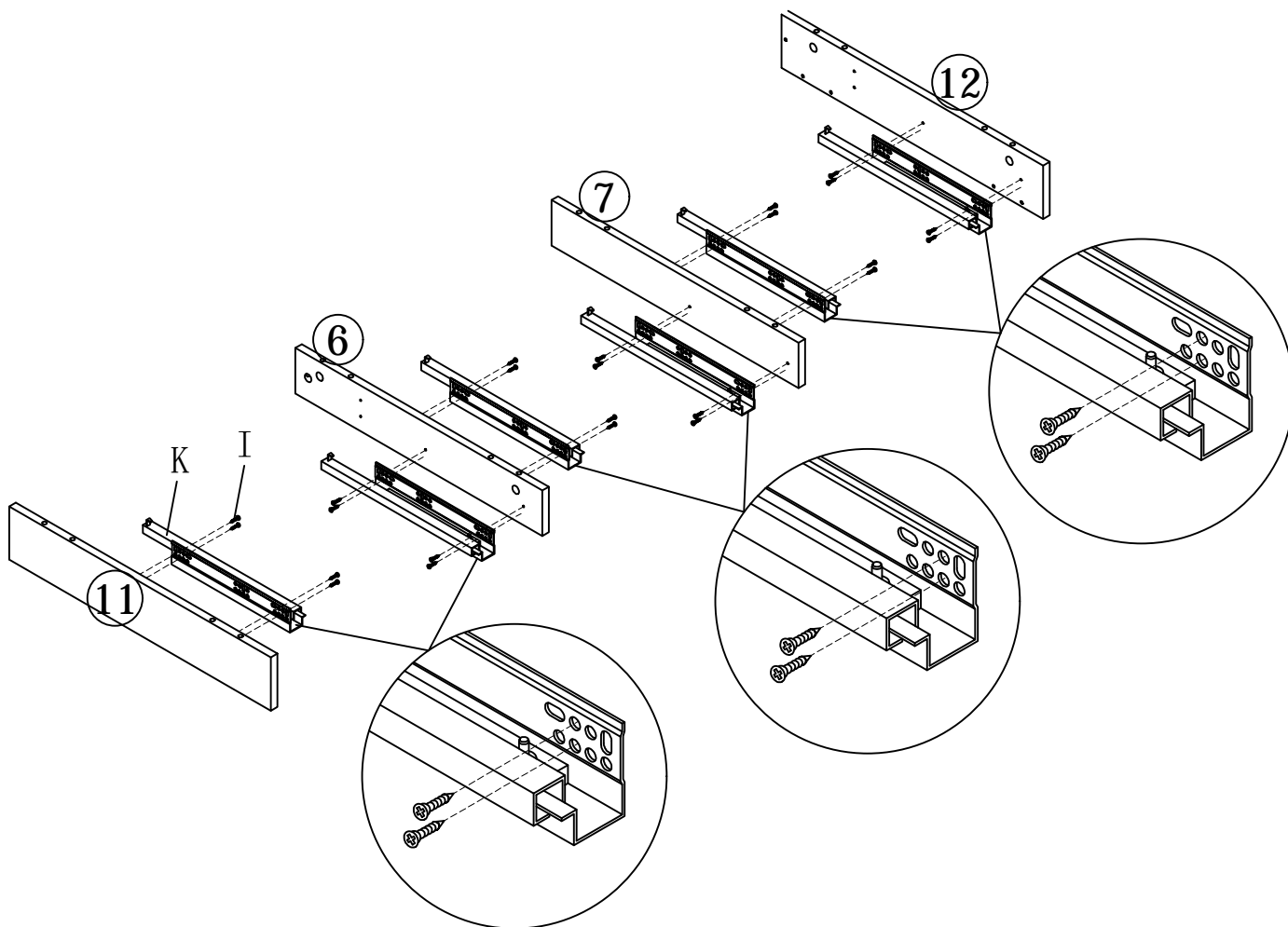

Use wood screw I and philips head screw driver to attach drawer slides K to end panel and partition 11&12&6&7.

ASSEMBLY INSTRUCTIONS

STEP 3:

Fx2
Gx2
Jx12

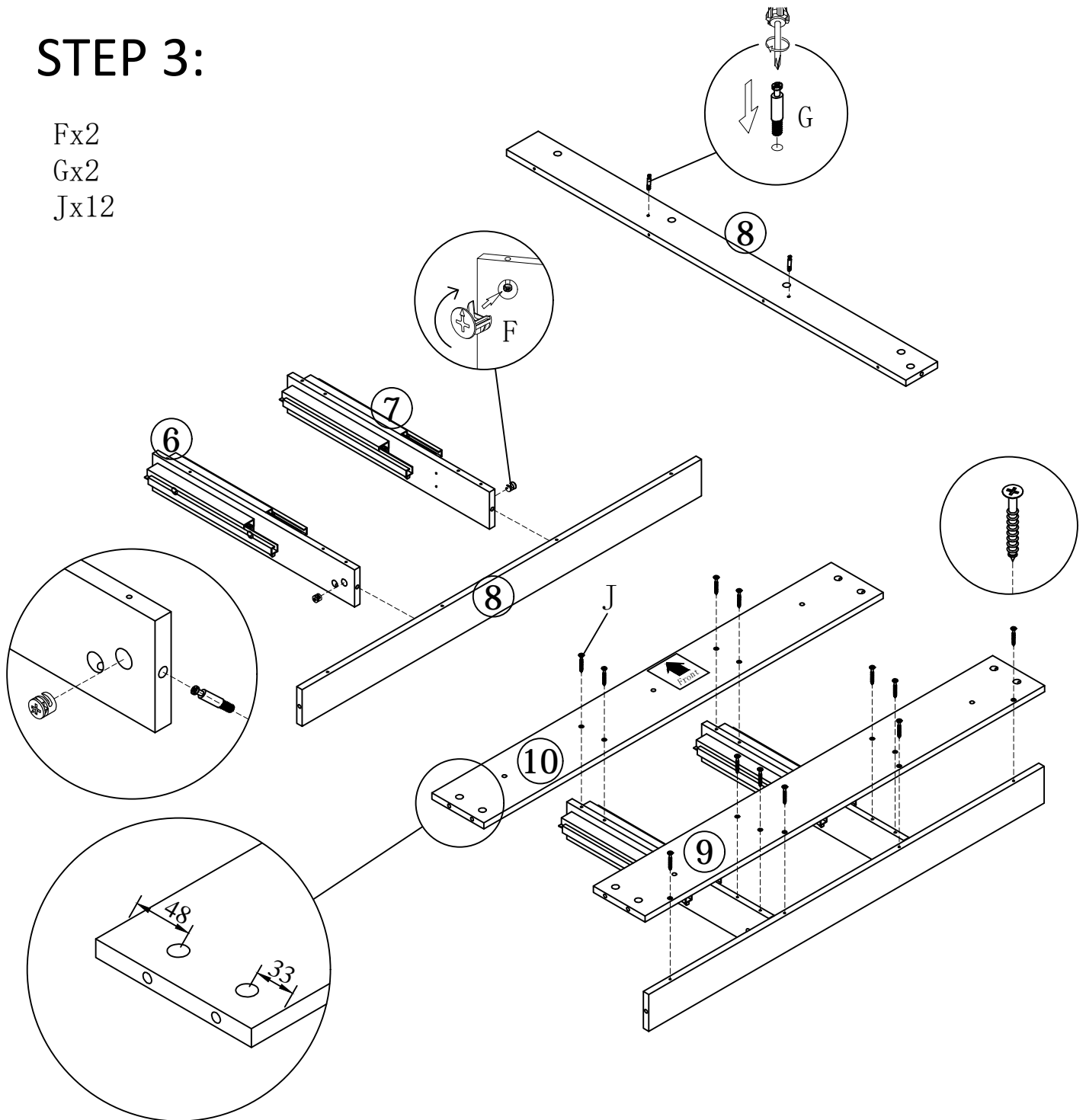

Turn the center partition 6&7 upside down, use philips head screw driver to fasten bolt F on inserts of back panel 8, bottom panel 9&10, then insert the bolts G on back panel 8 through end holes of center partition 6&7, put on cam unit F and fasten to secure. Use philips head screw driver and wood screw J to attach bottom panel 9&10 to bottom edge of center partition 6&7.

ASSEMBLY INSTRUCTIONS

STEP 4:

Fx10

Gx10

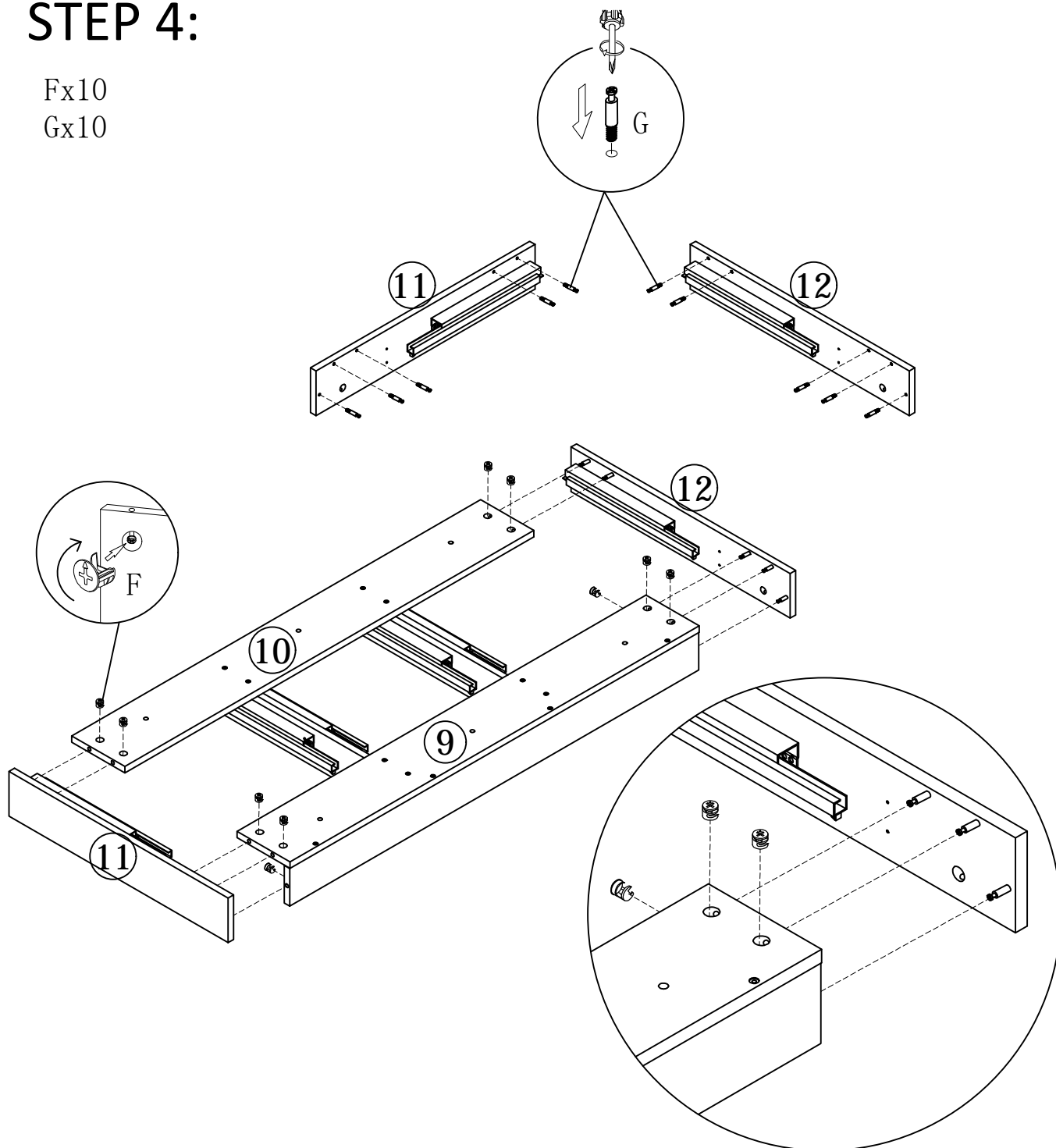

Use philips head screw driver to fasten bolt G on inserts of end panel 11 & 12, back panel 8, then insert the bolts G on end panel 11 & 12 through end holes of bottom panel 9 & 10, put on cam unit F and fasten to secure.

ASSEMBLY INSTRUCTIONS

STEP 5:

Fx12
Gx12
Hx8

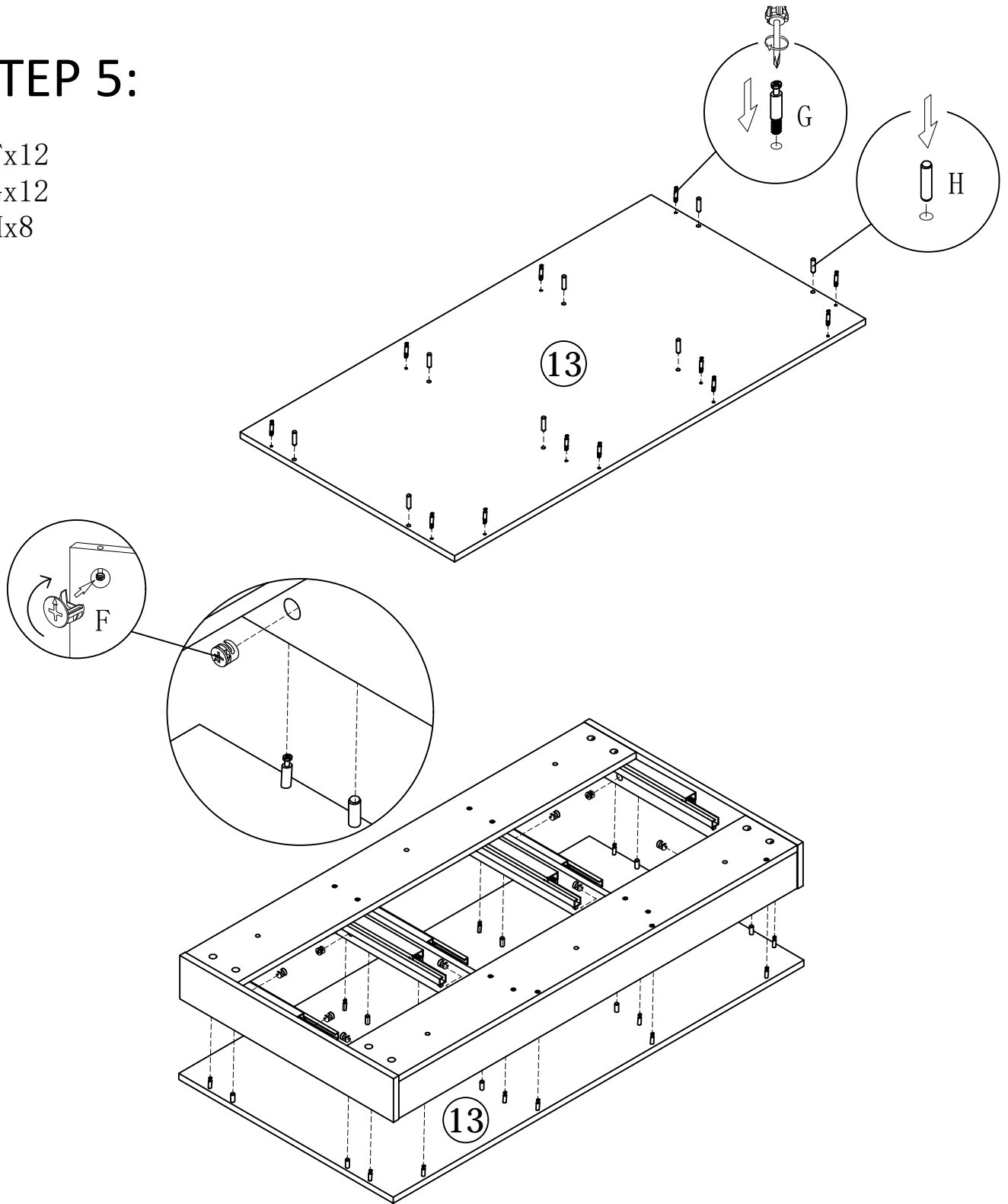

Use philips head screw driver to fasten bolt G on inserts of table top 13, Insert all dowels H to holes on back side of table top 13 then insert the bolts G on table top 13 through end holes of end/back/bottom panels assembly (6&7&8&9&10&11&12), put on cam unit F and fasten to secure.

ASSEMBLY INSTRUCTIONS

STEP 6:

Cx6

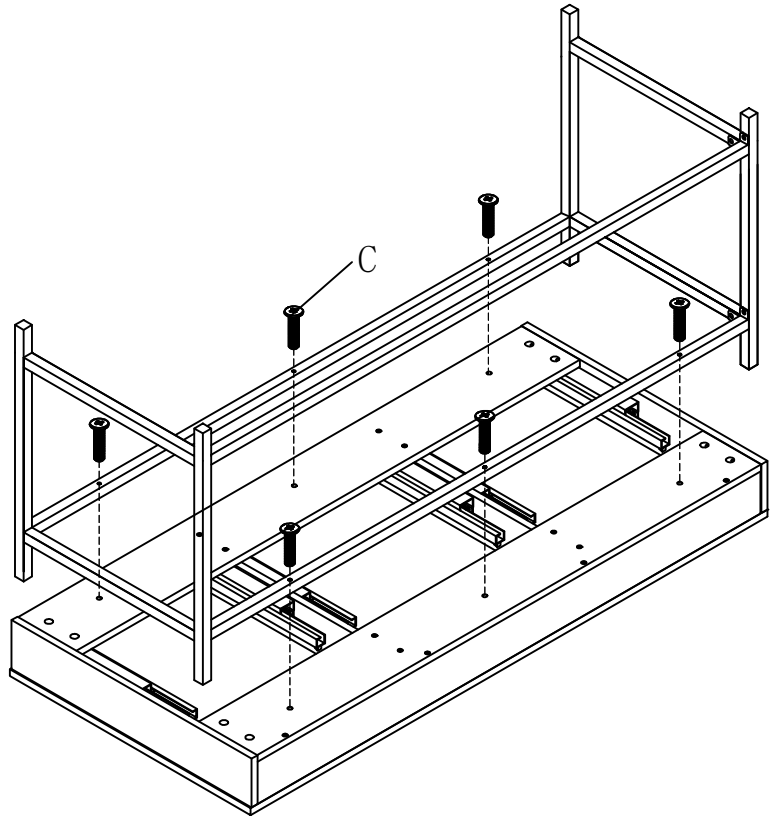
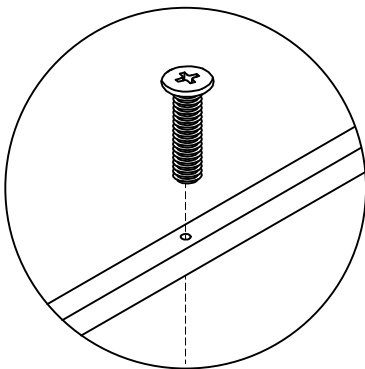

Use philips head screw driver and bolt C to attach the metal frame assembly to bottom of upper unit, make sure all edges align then fasten to secure.

ASSEMBLY INSTRUCTIONS

STEP 7:

Dx3
Ex3
Fx18
Gx18
Lx6

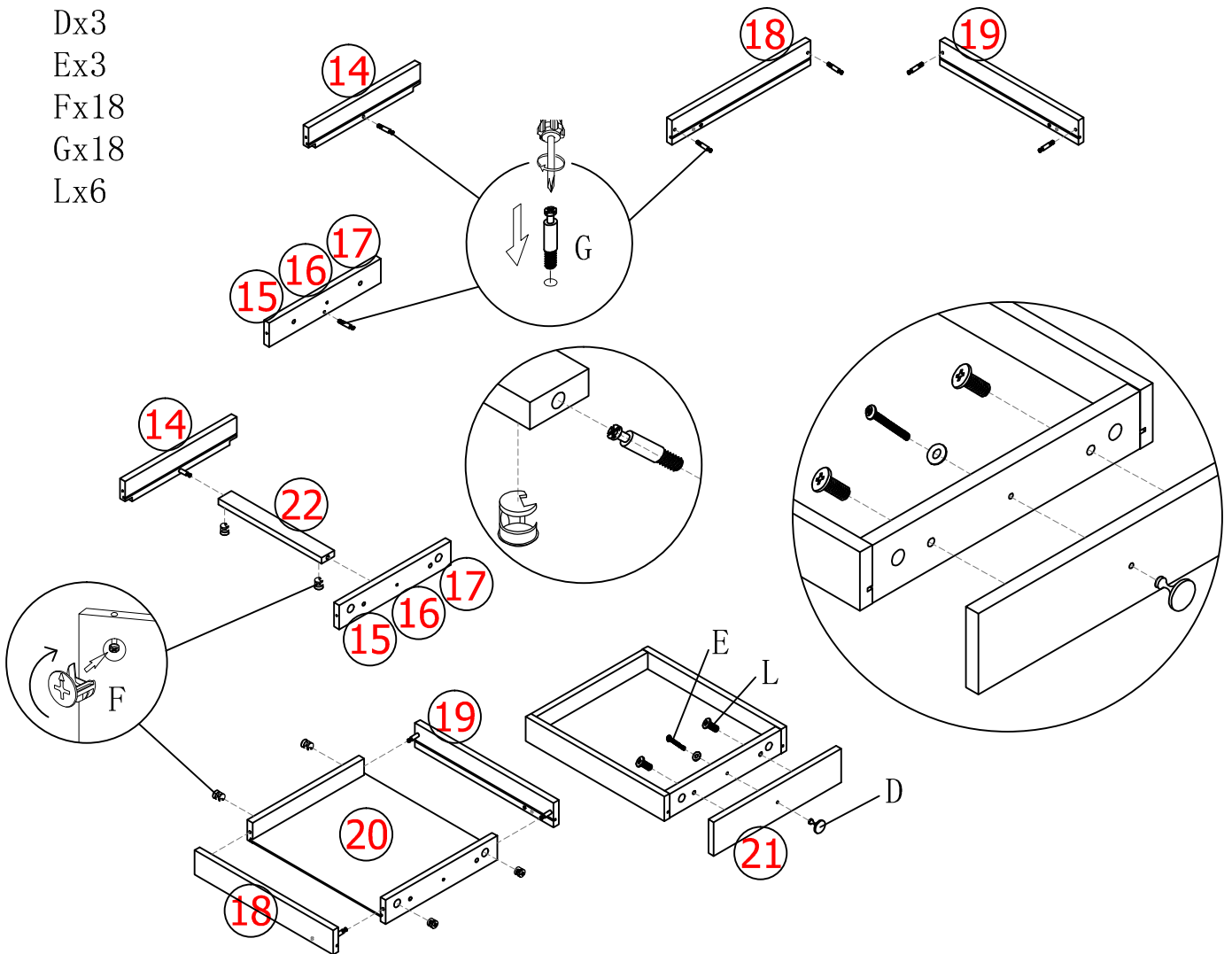

Use philips head screw driver to fasten bolt G on inserts of drawer front 15/16/17 and back 14 , put on cam unit F and fasten to secure.

Insert drawer bottom through channel along lower edge of drawer front 15/16/17 and back 14, insert the bolts G on end of drawer front 15/16/17 and back 14 through end holes of drawer sides 18/19, put on cam unit F and fasten to secure.

Use philips head screw driver, bolt L to attach drawer face 21 to assembled drawer box, make sure the drawer face align with drawer box then fasten to secure.

Use philips head screw driver, bolt and washer E to attach knob D to the drawer assembly, fasten to secure

ASSEMBLY INSTRUCTIONS

STEP 8:

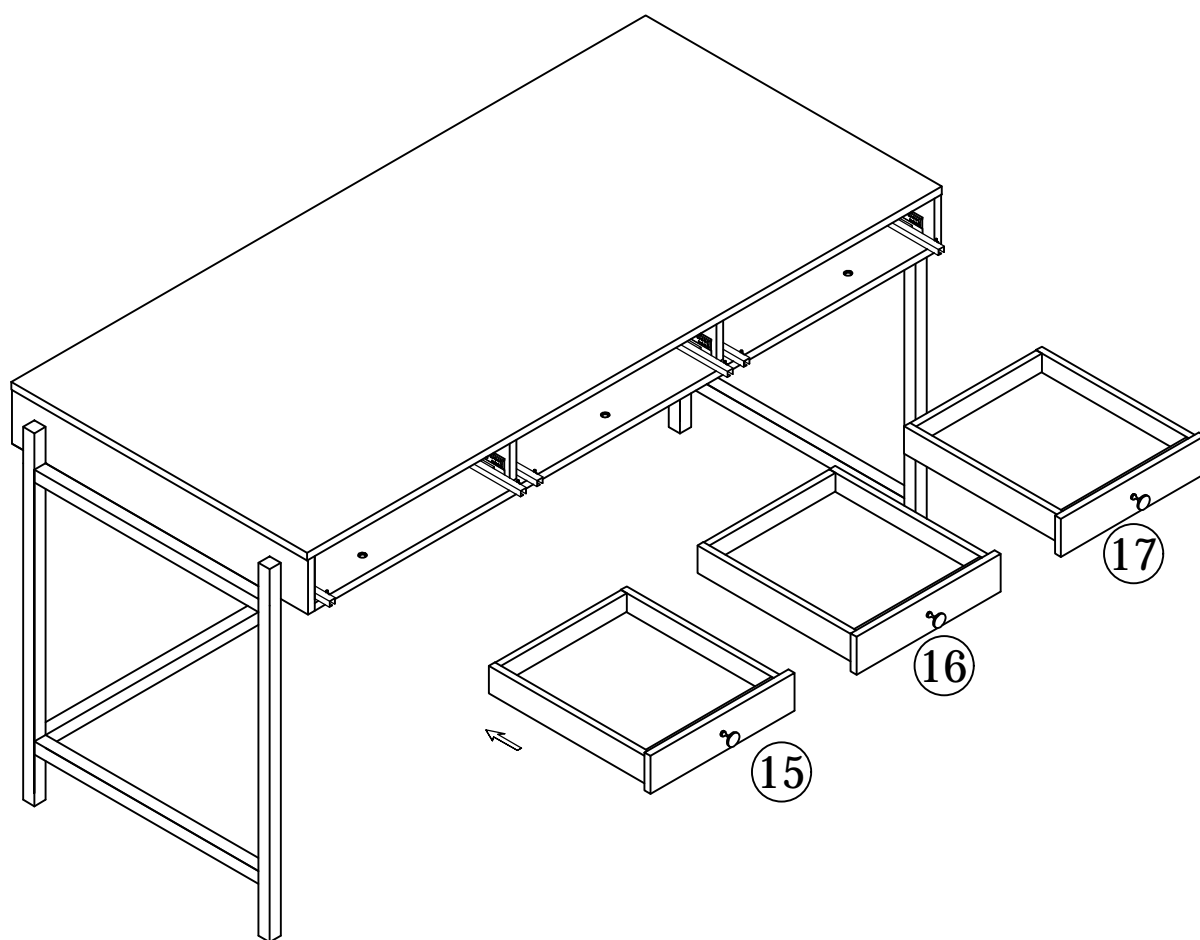

Pull out the drawer slides and carefully align the pin on drawer slides with the hole on drawer box then fix the clip to secure the drawer. Whenever drawer adjustment of drawers needed, please spin the pin on drawer slides to set it level.

ASSEMBLY INSTRUCTIONS

STEP 9:

Mx6

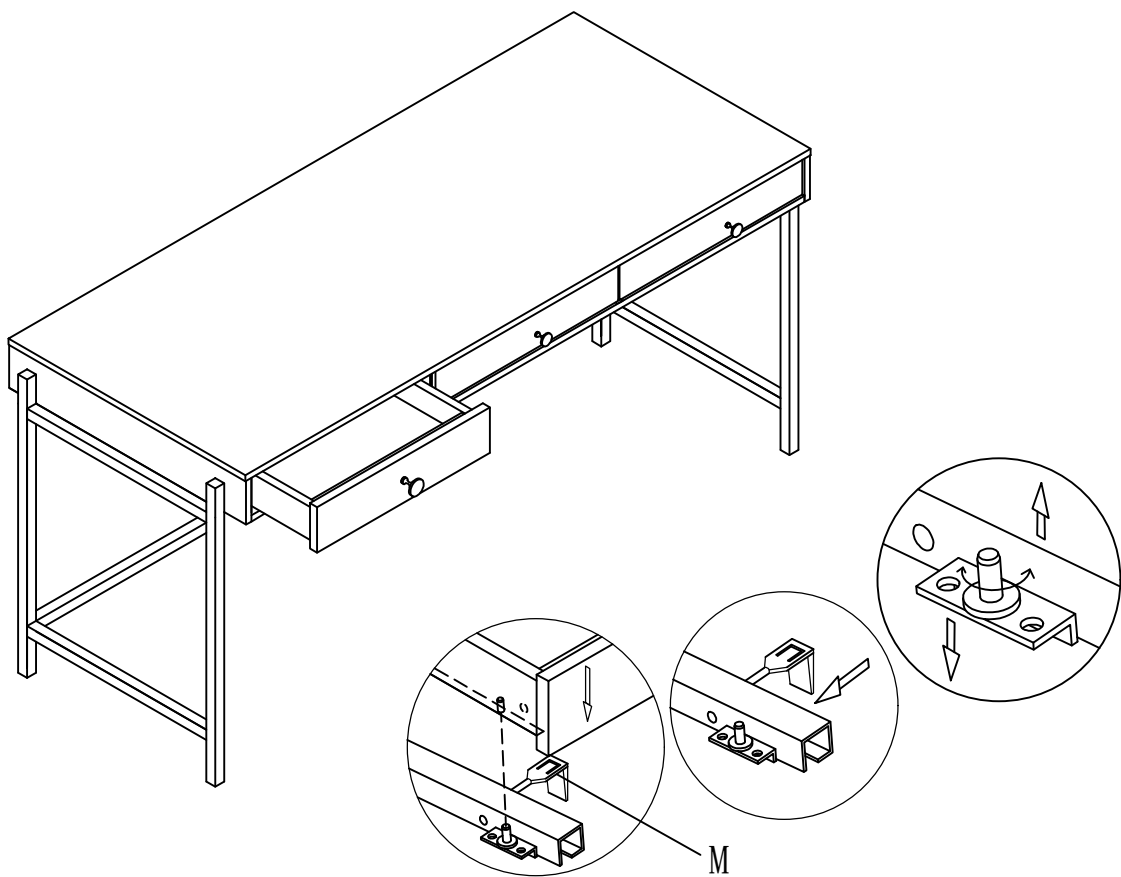

Switch the button with hand to slightly adjust the height of drawer sides in order to sent the drawer leveled. Insert the plastic clip M through the slide to the hole on drawer sides.

ASSEMBLY INSTRUCTIONS

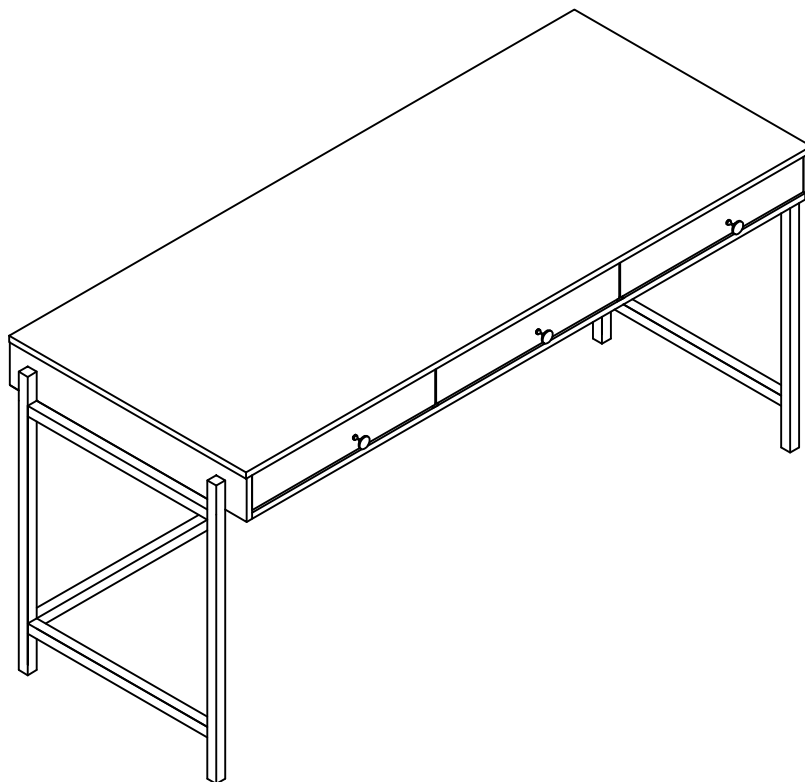

Assembly completed.