

HULALA

H O M E

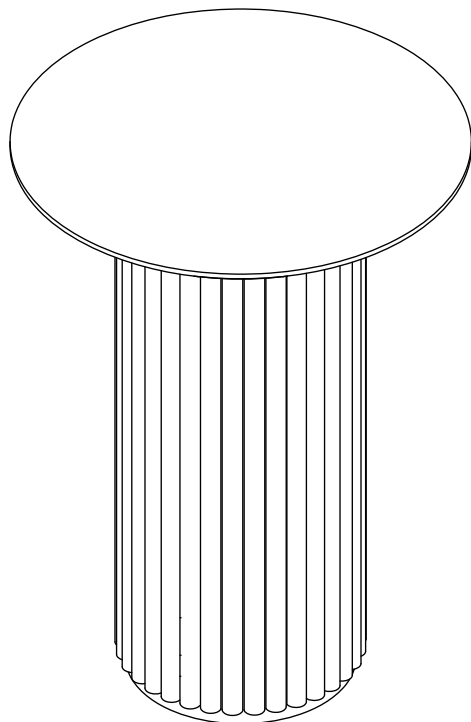

ITEM NO.ETSD1149

NOTE:

This brochure contains IMPORTANT safety info. Please read and keep for future reference.

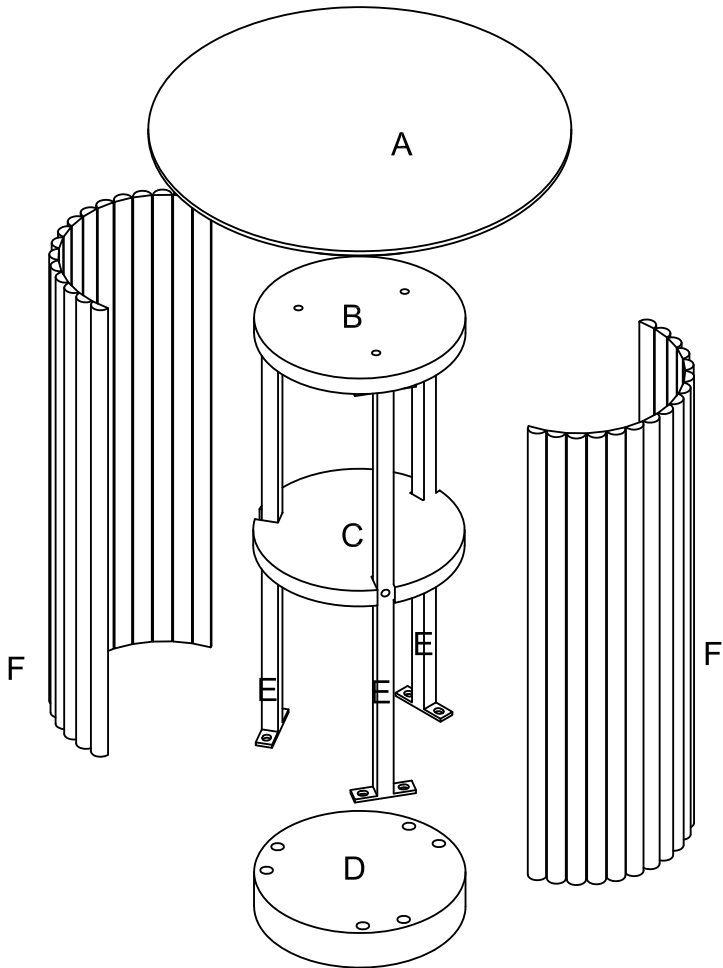

OVERVIEW

MAINTENANCE AND WARNING



- Keep furniture away from heat sources.
- Do not clean furniture with harsh cleaner or polishes. Do not use detergents, Solvents, abrasives, spray packs or leather cleaner. Use non-color mild soap with warm water to clean spills (Mix 1:10 soap to water)
- Do not place furniture under direct sunlight, material will possibly fade over time.
- Do not use on site dry Cleaning machine. Children should not climb or jump on the furniture.
- Do not write on furniture that is not protected by a padded barrier .
- Not for commercial use, only for residential use.



Weight Limitation

100 LBS

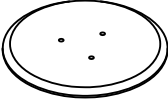
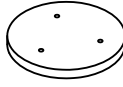
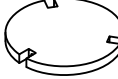
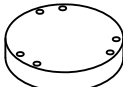

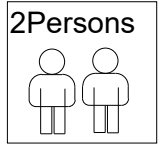

PARTS LIST 1

| | | | |
|---|---|---|---|
| A  | B  | C  | D  |
| 1 PC | 1 PC | 1 PC | 1 PC |
| E  | F  | | |
| 3PCS | 2PCS | | |



Persons Required For Assembly:

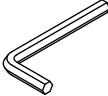

PARTS LIST 2

| | | | | | | | | | |
|---|-----|---|----|---|----|---|----|---|----|
| ① | x12 | ② | x3 | ③ | x3 | ④ | x4 | ⑤ | x1 |
|  | |  | |  | |  | |  | |
| M6*15mm | | M6*30mm | | M7*50mm | | Ø30 | | M4 | |

SPARE



| | | | | | |
|---|----|---|----|---|----|
| ① | x1 | ② | x1 | ③ | x1 |
|  | |  | |  | |
| M6*15mm | | M6*30mm | | M7*50mm | |

Be sure to inspect all packing material carefully for small parts, that may have come loose inside the carton during shipment.

STEP 1

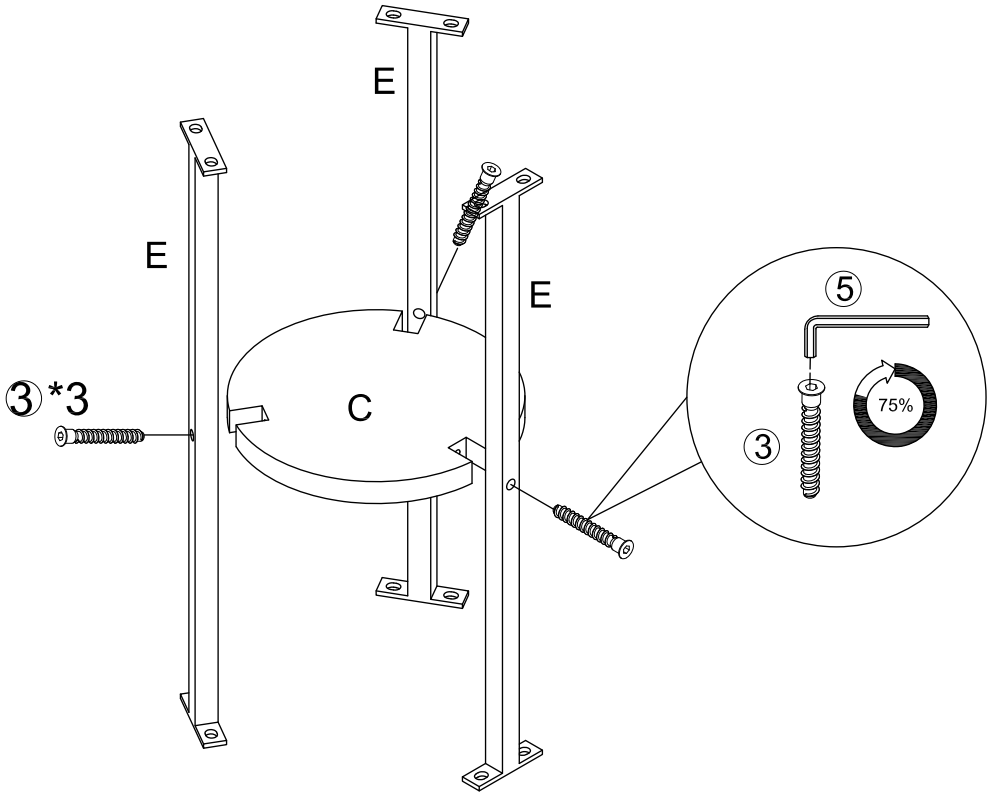
Lock three Connection Pipes E with the plate C by using Screw 3 and Wrench 5.
DO NOT FULLY TIGHTEN THE SCREWS.





| ③ | x3 | ⑤ | x1 |
|---|----|--|----|
|  | |  | |
| M7*50mm | | M4 | |

STEP 2

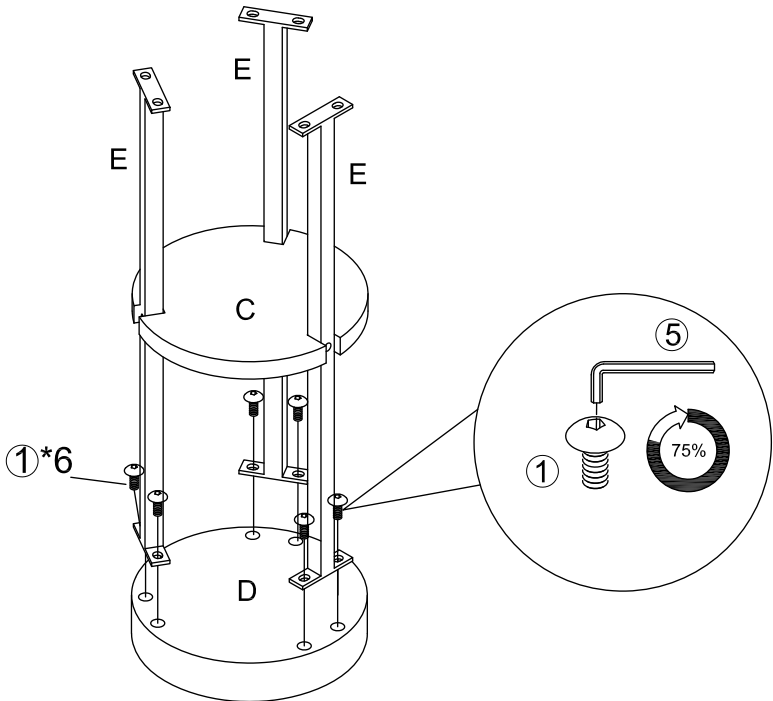
Place the Plate D on a flat surface. Lock three Connection Pipes E with the Bottom plate D by using Screw 1 and Wrench 5.
DO NOT FULLY TIGHTEN THE SCREWS.





| | | | |
|---|----|---|----|
| ① | x6 | ⑤ | x1 |
|  | |  | |
| M6*15mm | | M4 | |

STEP 3

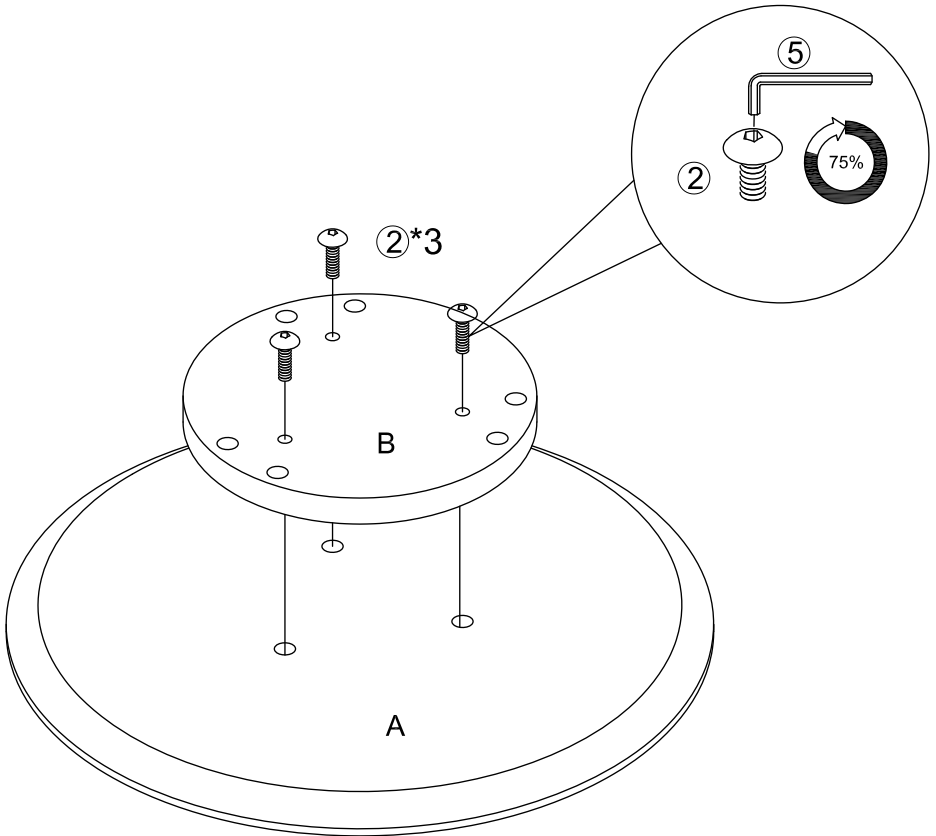
Take out The Panel A and place it on a flat surface, Attach the Plate B with The Panel A by using Screws 2 and Wrench 5





| | | | |
|---|----|--|----|
| ② | x3 | ⑤ | x1 |
|  | |  | |
| M6*30mm | | M4 | |

STEP 4

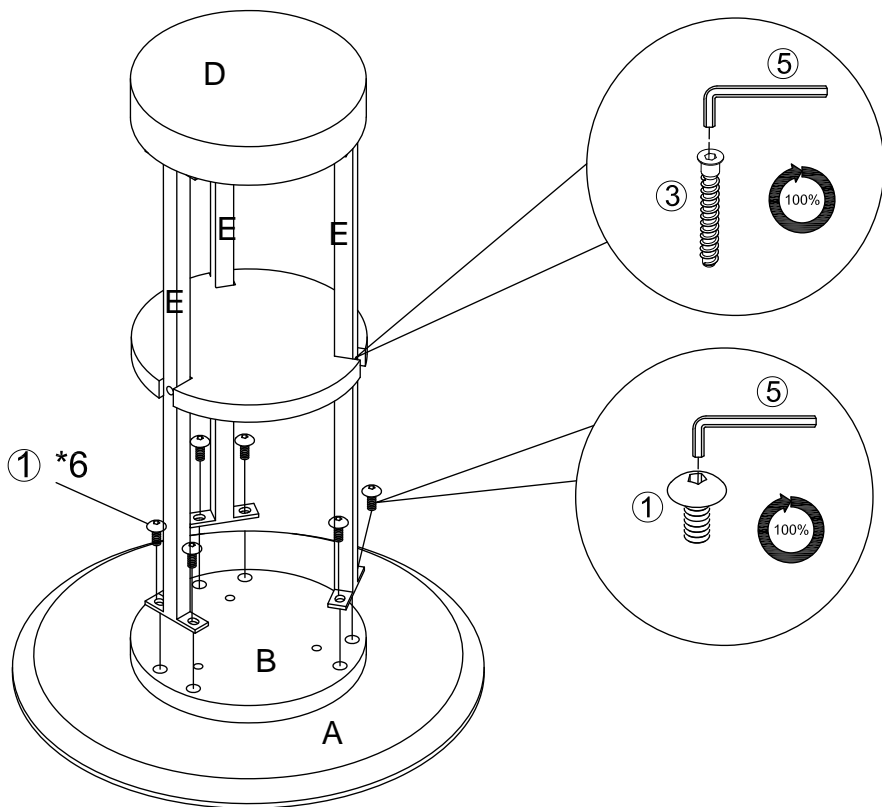
Attach three Connection Pipes E between the Plate D and the Plate B using Screws 1 and Wrench 5. Then fix all the Screws firmly in place.



| | | | |
|---|----|---|----|
| ① | x6 | ⑤ | x1 |
|  | |  | |
| M6*15mm | | M4 | |

STEP 5

1. Paste the EVA Footpad on the Plate C.

2. Affix the Plate F between the Plate B and the Plate D

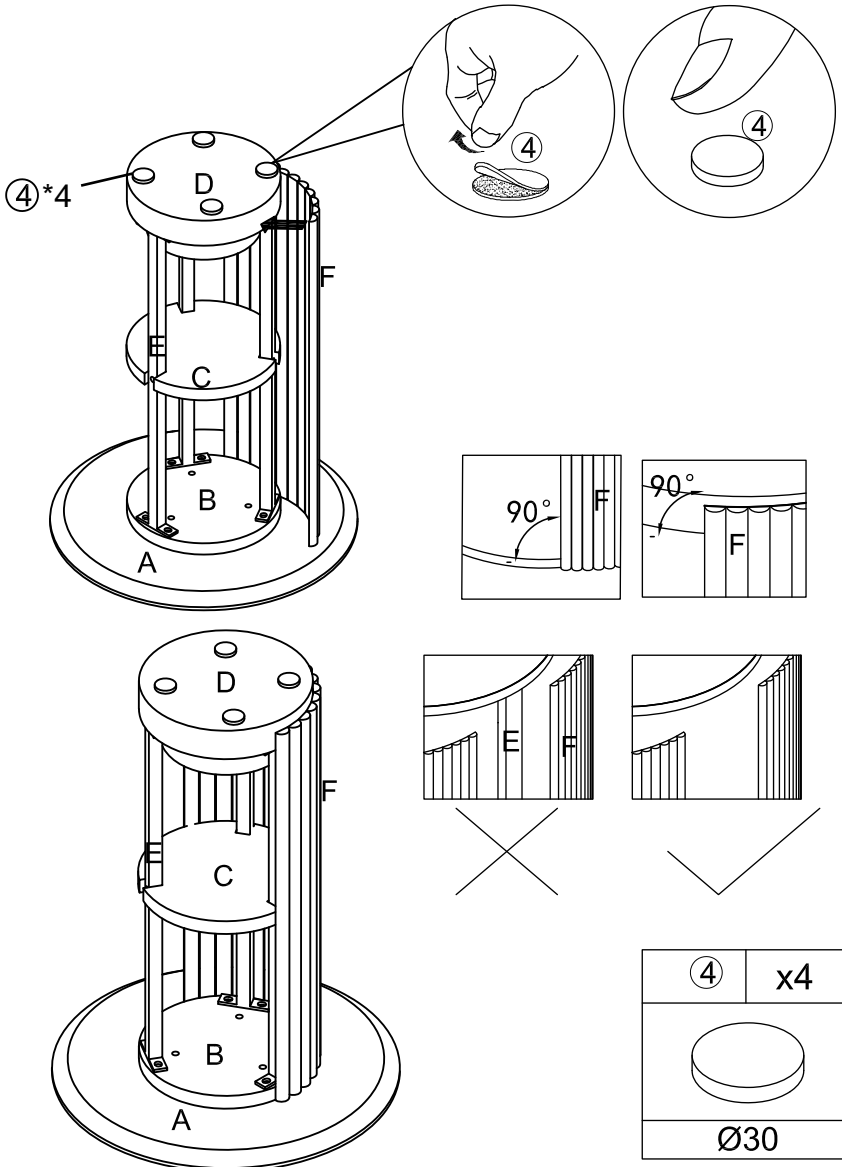

STEP 7

Affix the Plate F between the Plate B and the Plate D

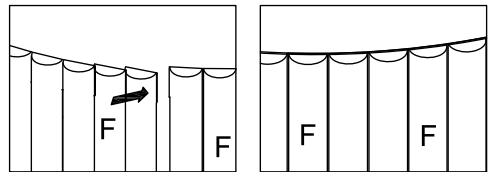
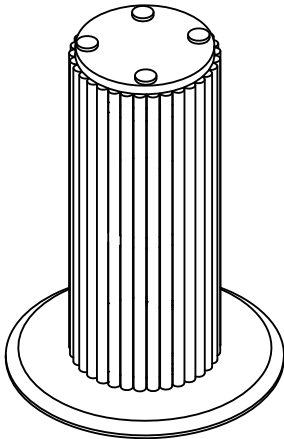
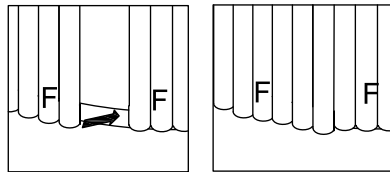
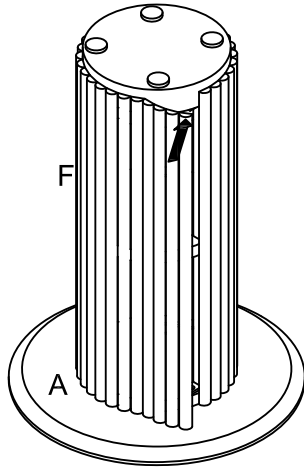

WARRANTY

We strive to offer high-quality products, and we also try our best to satisfy each and every customer that orders from us with product or service as needed. We provide 30 days warranty starting from the time you receive the item. Each customer must provide a record of their order such as the order number, or item receipt for any items that are out of the warranty period you may also still receive replacement parts by purchasing them with our company if they are available.

Are you having difficulty
with assembly? Missing parts?
Please send email with your order No to
customerservice@hulalahome.com
For return, please check the return policy with
the retailer or market place you bought from.

Appreciate your purchasing from us.
Pop up your life by our furniture piece!