

Assembly Instructions

ITEM NO: LBL4567

1. Remove all parts from the carton A&B and place them on a protected surface or carpet.

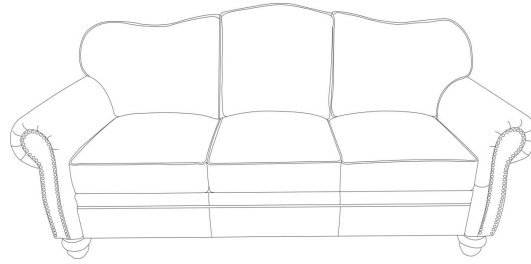

The "A" box contains the following parts :

1 Seat



3 Seat Cushions



3 Back Cushions

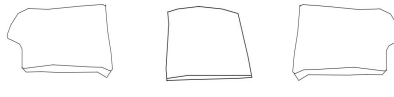

The "B" box contains the following parts :

1 Back



2 Arms

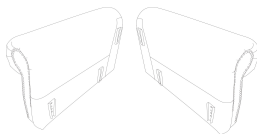

4 Wood Legs



1 Plastic Leg



5 Butterfly Screws



5 Flat washers



5 Butterfly Nuts



SPARE

1 Butterfly Screw



1 Flat washer



1 Butterfly Nut



2. Hang the left side facing seat over the left side facing arm as shown, make sure the male and female brackets align firmly as shown. Same as the right side facing seat and the right side facing seat arm. (Two person needed here.)

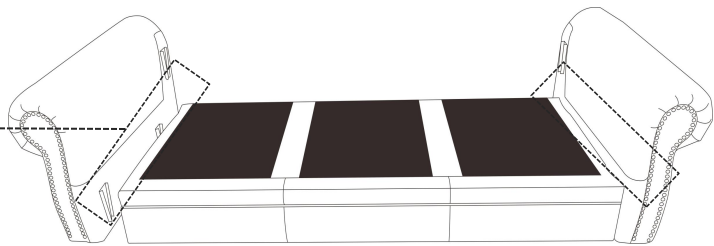
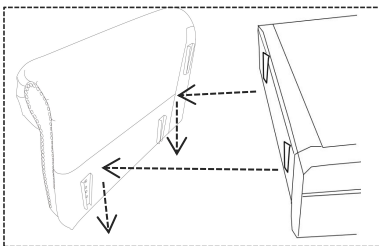

3. Attach the back to the seat and arm as shown, make sure that all the male and female brackets align firmly as shown. (Two person needed here.)

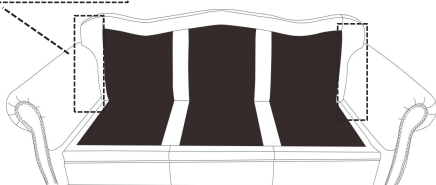
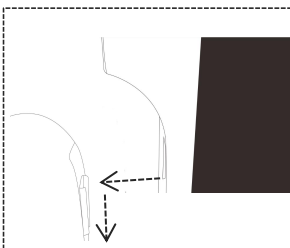

4. Align each hole of the screw, then insert in each butterfly screw and put on each flat washer, tighten them firmly by Butterfly Nuts as shown. Attach the plastic leg to the middle bottom of the seat as shown. Attach the 4 Wood legs to the bottom of each arm as shown.

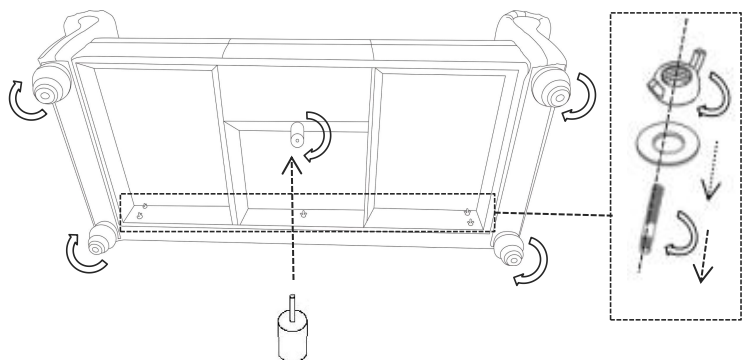

5. Attach each seat cushion to the seat, make sure they are settled by correct direction.
Attach each back cushion to the back, make sure they are settled by correct direction(Left, Middle, Right).

