

WARRANTY

- 1.We strive to offer high-quality products,and we also try our best to satisfy each and every customer that orders from us with product or service as needed.
- 2.We provide 30 days warranty starting from the time you receive the item.Each customer must provide a record of their order such as the order number,or item receipt for any items that are out of the warranty period you may also still receive.
- 3.Replacement parts by purchasing them with our company if they are available.

Are you having difficulty
With assembly?Missing parts?

Please send email with your order No to
customerservice@hulalahome.com

For return,please check the return policy with
the retailer or market place you bought from.

Appreciate your purchasing from us.
Pop up your life by our furniture piece!

HULALA

H O M E

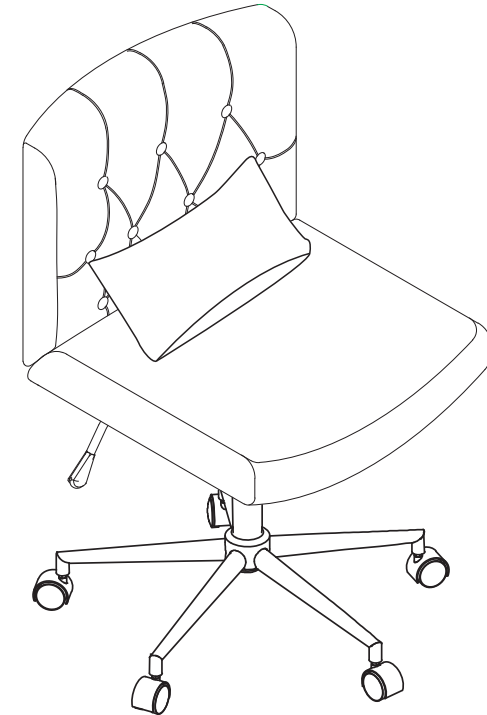

ITEM NO.OFM1069

NOTE:







This brochure contains IMPORTANT safety info. Please read and keep for future reference.

MAINTAINANCE AND WARNING

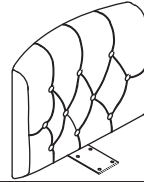
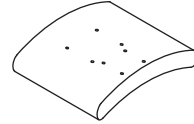
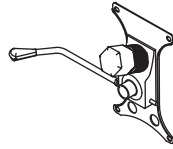

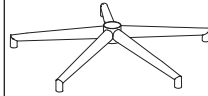
- 1.Keep furniture away from heat sources.
- 2.Do not clean furniture with harsh cleaner or polishes.Do not use detergents,solvents,abrasives,spray packs or leather cleaner. Use non-color mild soa with warm water to clean spills(Mix 1:10 soap to water).
- 3.Do not place furniture under direct sunlight,material will possibly fade over time.
- 4.Do not use on site dry cleaning machine.Children should not climb or jump on the furniture.
- 5.Do not write on furniture that is not protectedby a padded barrier.
- 6.Not for commercial use,only for residential use.

 Weight Limitation
250 LBS



PARTS LIST

A	x1	B	x1	C	x1	D	x1
							
Seat frame		Spider base		Gas lift		Gas hat	
E	x1	F	x5	G	x1	H	x1
							
Spider base		Casters		Metal base cap		Throw pillows	

HARDWARE LIST

#1	x4	#2	x4	#3	x1
					
Bolt		Bolt		Allen Key	
M6*20		M6*25		M6	

HARDWARE SPARE LIST

#1	x1	#2	x1
			
Bolt		Bolt	
M6*20		M6*25	

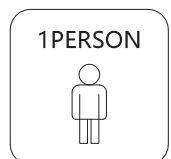

ASSEMBLY INSTRUCTIONS

STEP-1

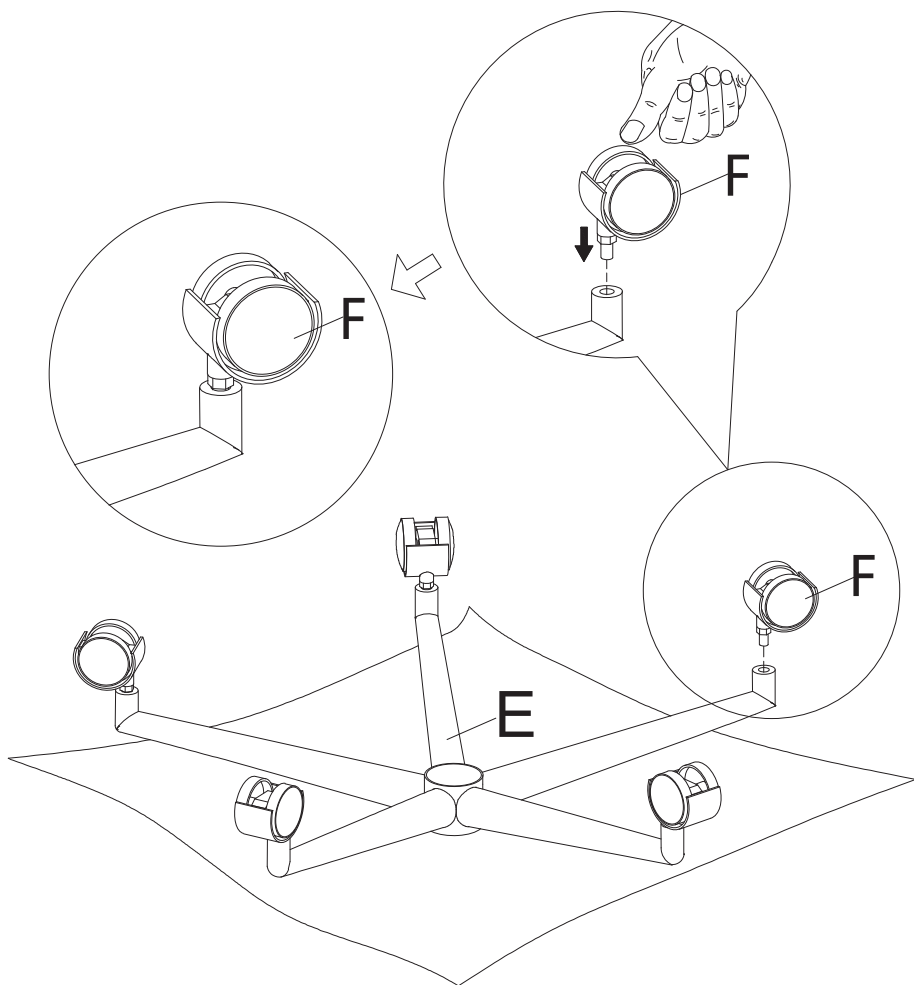

ASSEMBLY INSTRUCTIONS

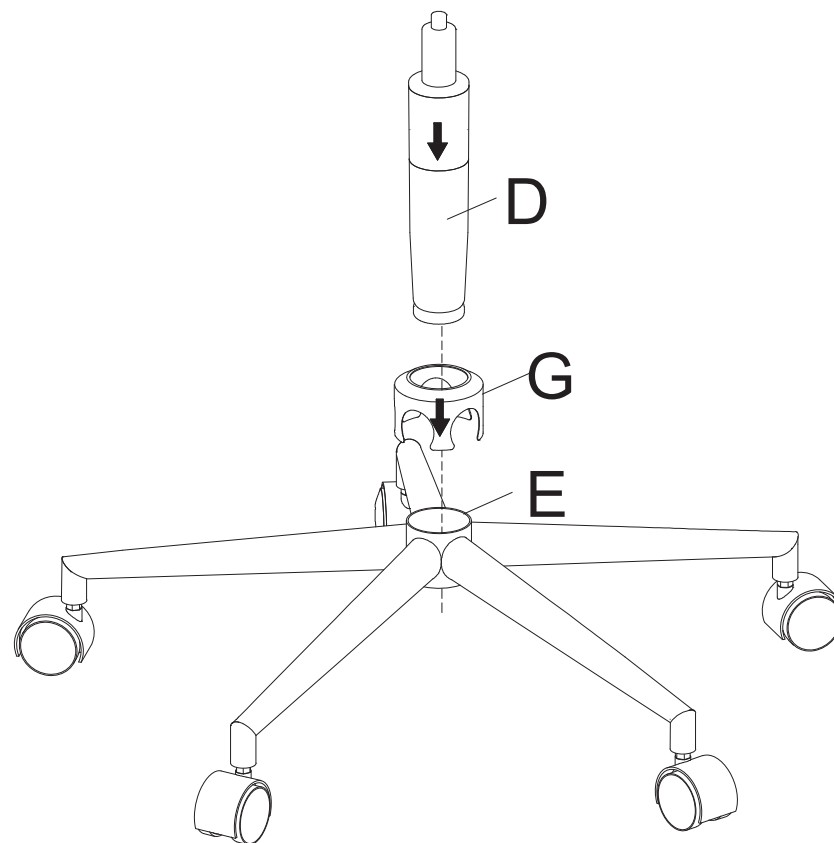

STEP-2

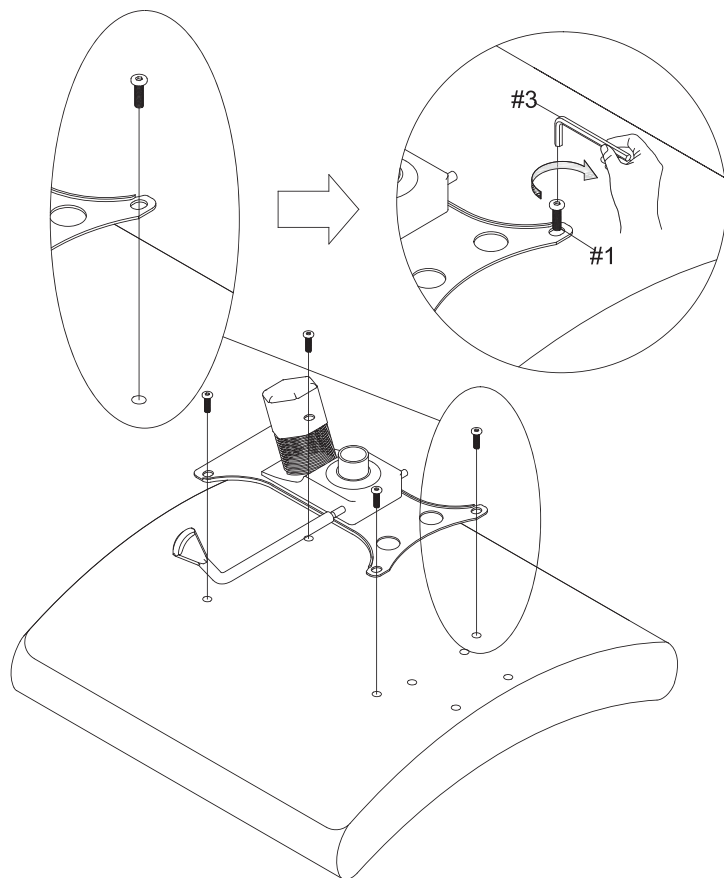

ASSEMBLY INSTRUCTIONS

STEP-3



#1	x4	#3	x1
			
Bolt		Allen Key	
M6*20			

ASSEMBLY INSTRUCTIONS

STEP-4

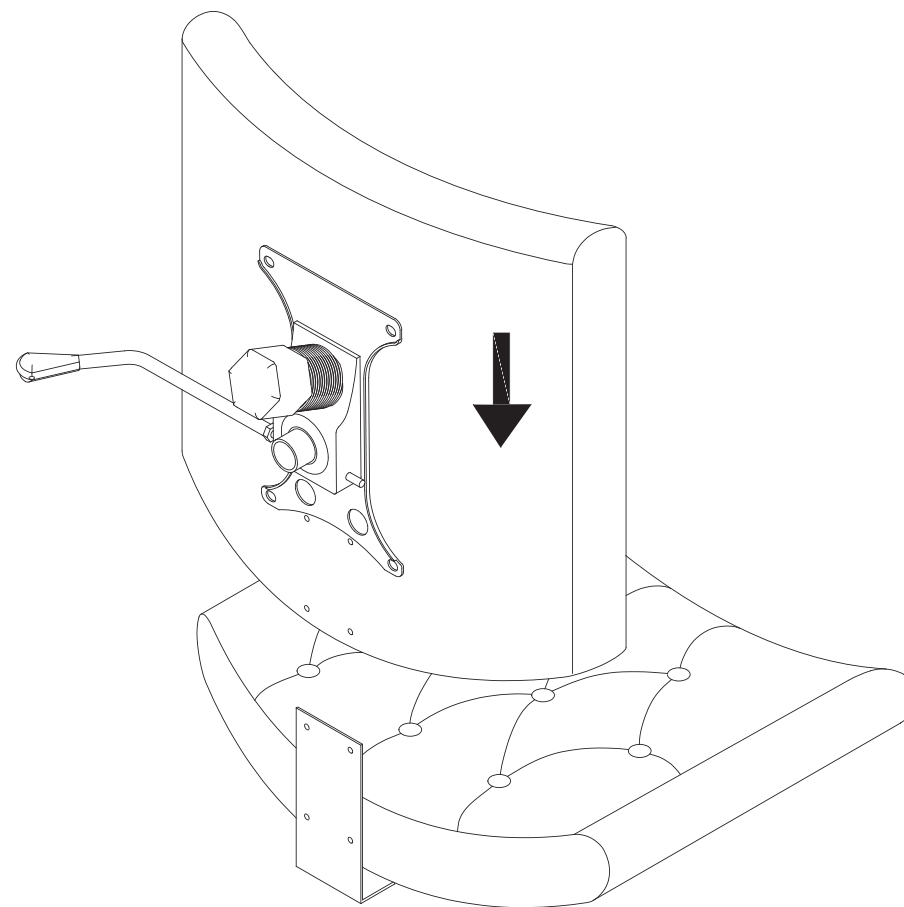

Make sure the backrest plate is pressed against the pallet.

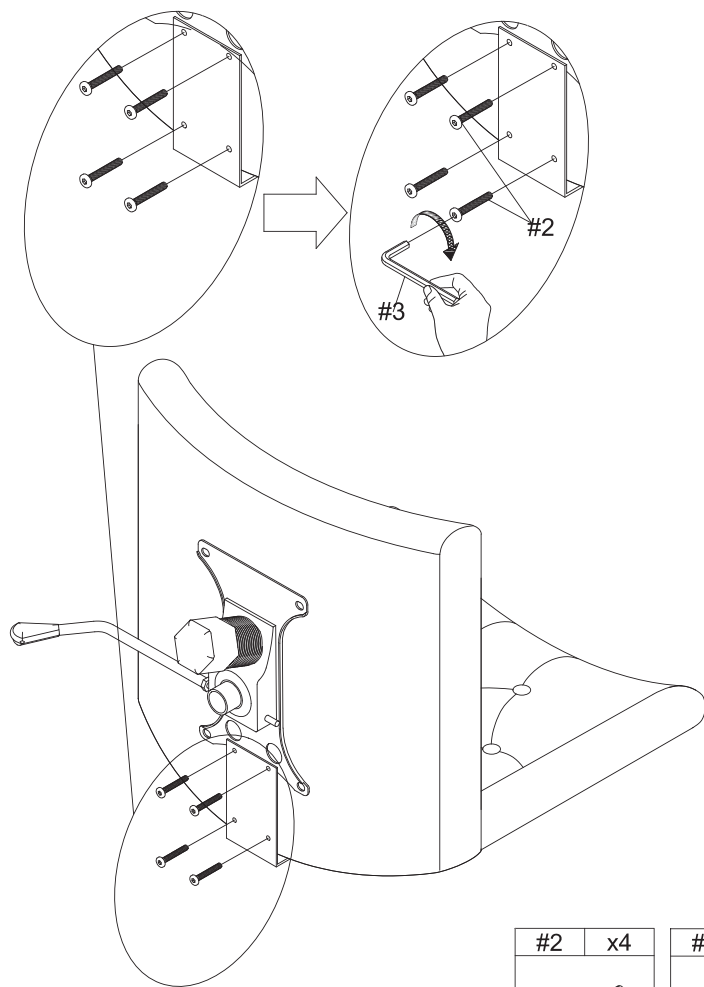

ASSEMBLY INSTRUCTIONS

STEP-5



#2	x4	#3	x1
			
Bolt		Allen Key	
M6*25			

ASSEMBLY INSTRUCTIONS

STEP-6

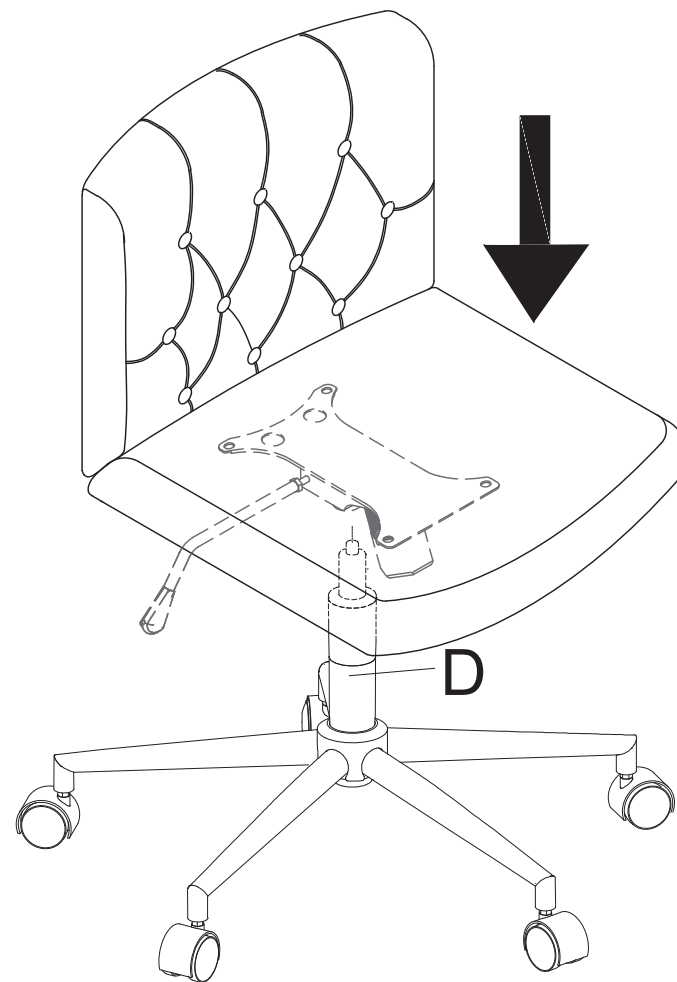

ASSEMBLY INSTRUCTIONS

STEP-7

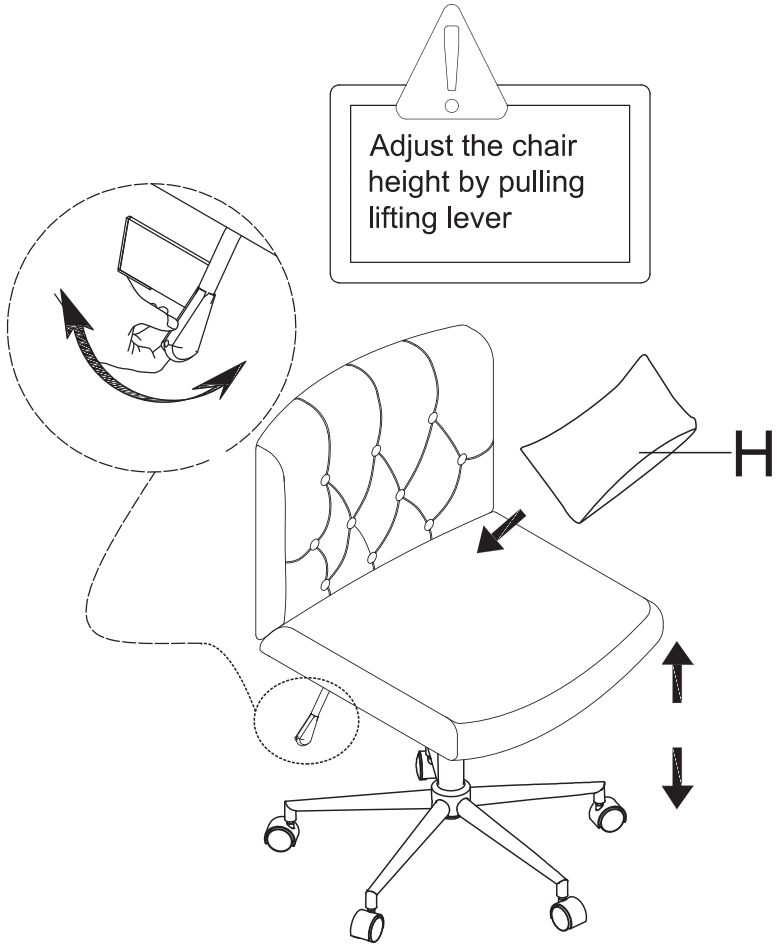

adjust forward and backward tilt angle of chair by rotating rotary knob under chair