

## WARRANTY

- 1.We strive to offer high-quality products,and we also try our best to satisfy each and every customer that orders from us with product or service as needed.
- 2.We provide 30 days warranty starting from the time you receive the item.Each customer must provide a record of their order such as the order number,or item receipt for any items that are out of the warranty period you may also still receive.
- 3.Replacement parts by purchasing them with our company if they are available.

Are you having difficulty  
With assembly?Missing parts?  
Please send email with your order No to  
[customerservice@hulalahome.com](mailto:customerservice@hulalahome.com)

For return,please check the return policy with  
the retailer or market place you bought from.

Appreciate your purchasing from us.  
Pop up your life by our furniture piece!

# HULALA

---

H O M E



## ITEM NO.OFM1111

---

### NOTE:

This brochure contains IMPORTANT safety info. Please read and keep for future reference.







---

## MAINTAINANCE AND WARNING

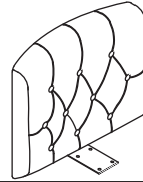
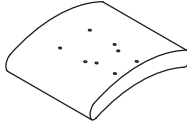
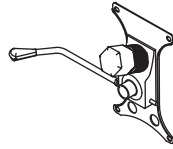

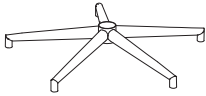
- 1.Keep furniture away from heat sources.
- 2.Do not clean furniture with harsh cleaner or polishes.Do not use detergents,solvents,abrasives,spray packs or leather cleaner. Use non-color mild soa with warm water to clean spills(Mix 1:10 soap to water).
- 3.Do not place furniture under direct sunlight,material will possibly fade over time.
- 4.Do not use on site dry cleaning machine.Children should not climb or jump on the furniture.
- 5.Do not write on furniture that is not protectedby a padded barrier.
- 6.Not for commercial use,only for residential use.





## PARTS LIST

A	x1	B	x1	C	x1	D	x1
							
Seat frame		Spider base		Mechanism		Gas hat	
E	x1	F	x5	G	x1	H	x1
							
Spider base		Casters		Metal base cap		Throw pillows	

## HARDWARE LIST

#1	x4	#2	x4	#3	x1
					
Bolt M6*20		Bolt M6*25		Allen Key M6	

## HARDWARE SPARE LIST

#1	x1	#2	x1
			
Bolt M6*20		Bolt M6*25	

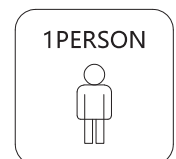

# ASSEMBLY INSTRUCTIONS

## STEP-1

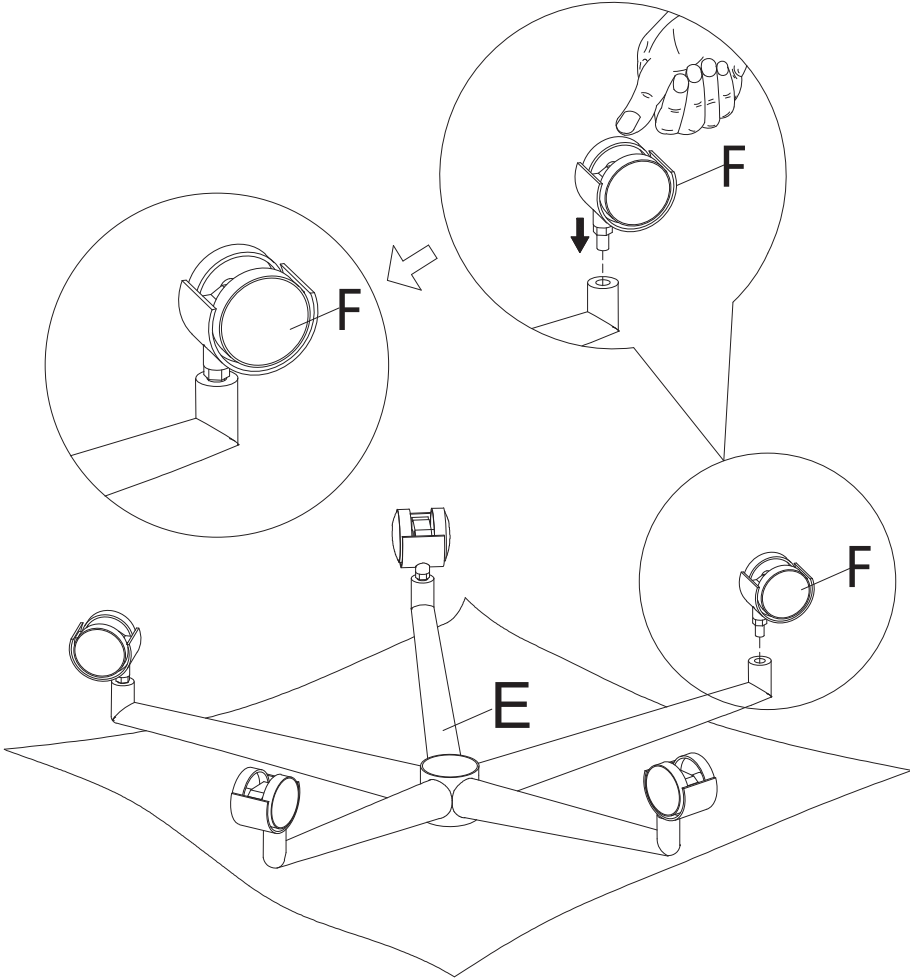

# ASSEMBLY INSTRUCTIONS

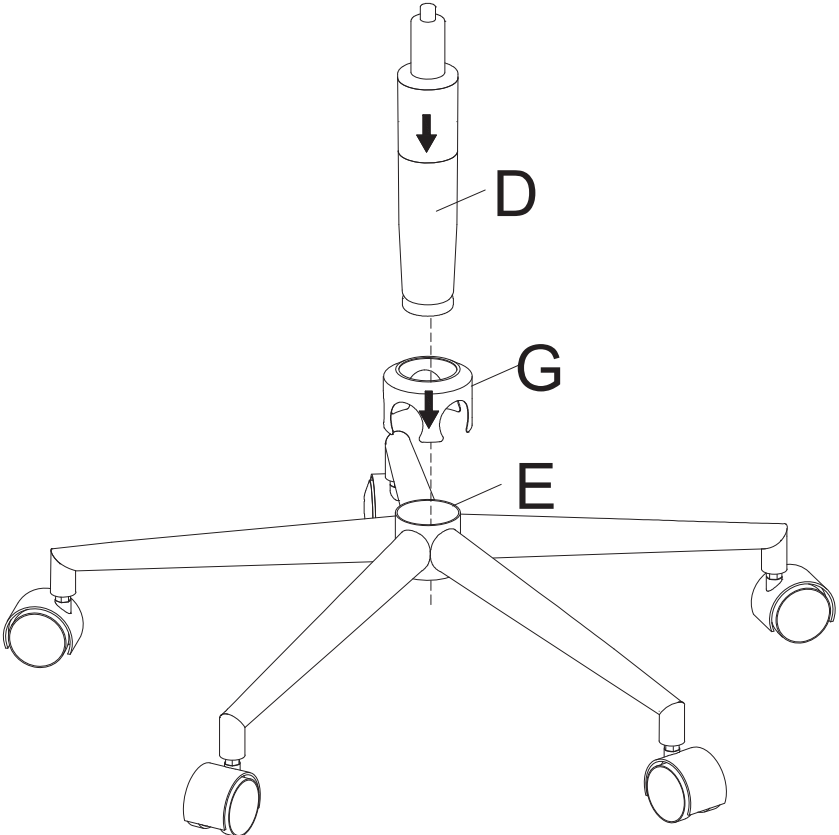

## STEP-2

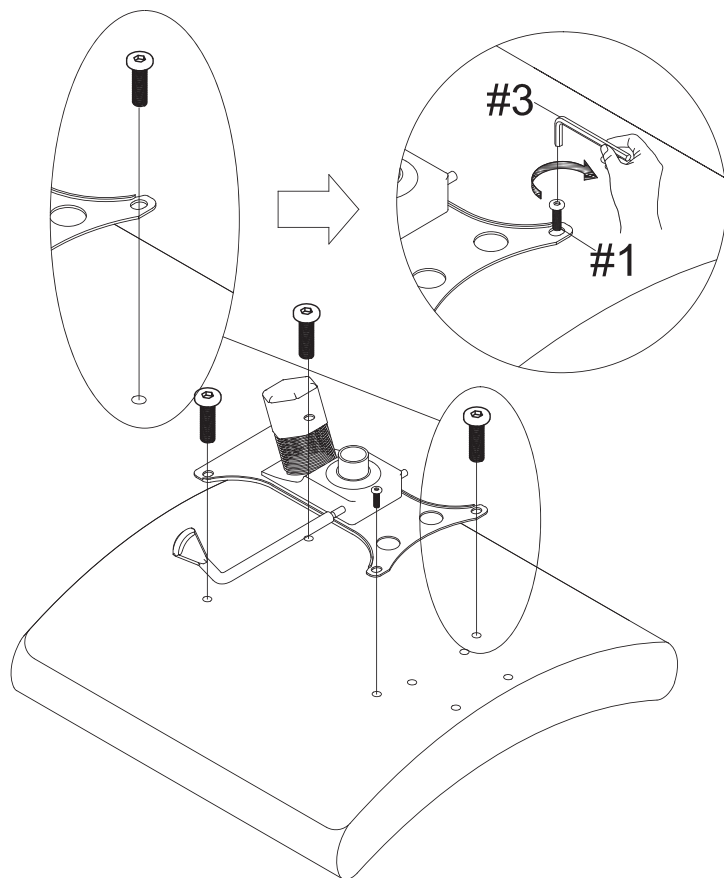

## ASSEMBLY INSTRUCTIONS

### STEP-3



#1	x4	#3	x1
			
Bolt		Allen Key	
M6*20			

## ASSEMBLY INSTRUCTIONS

### STEP-4

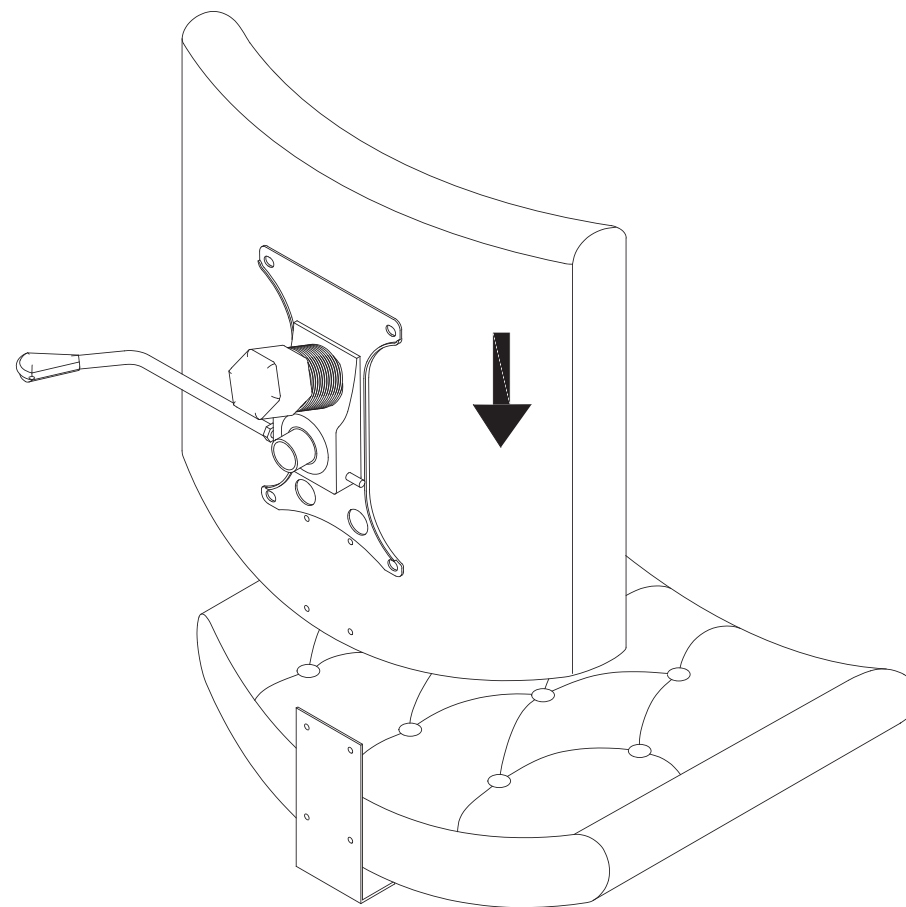

Make sure the backrest plate is pressed against the pallet.

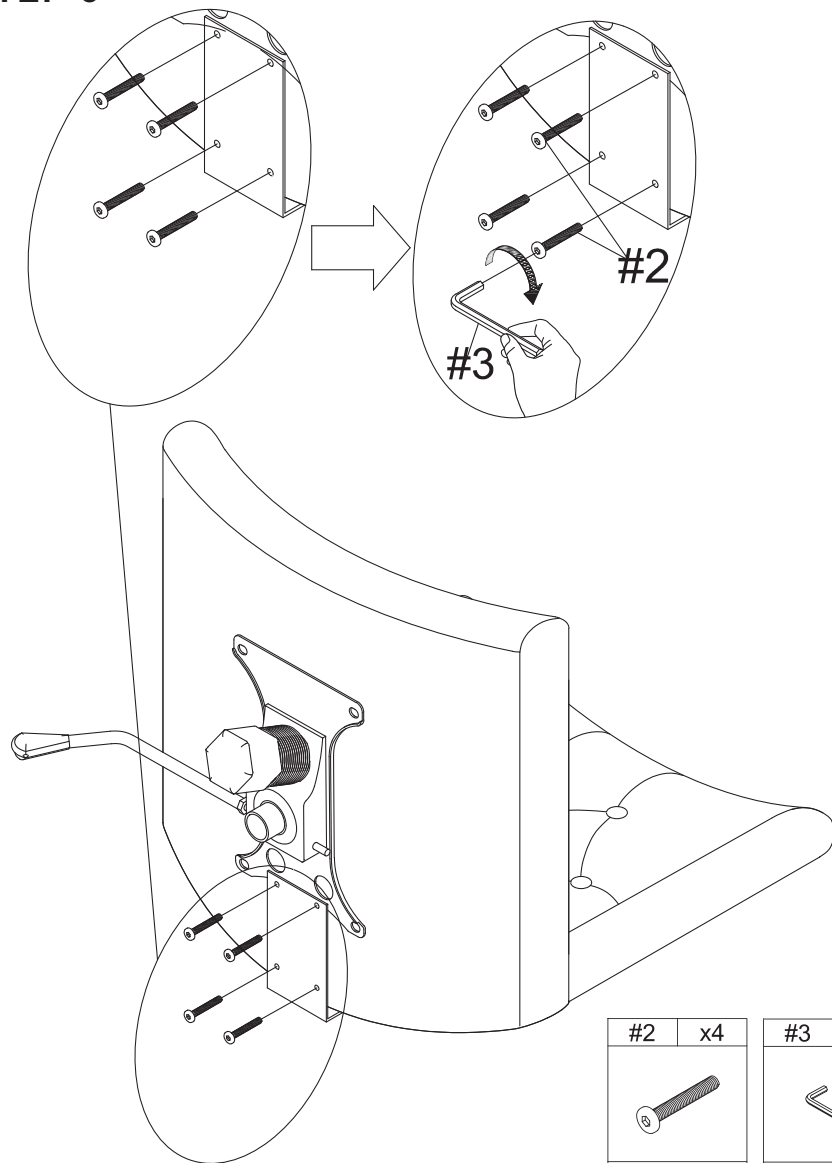

# ASSEMBLY INSTRUCTIONS

## STEP-5



#2	x4	#3	x1
			
Bolt M6*25		Allen Key	

# ASSEMBLY INSTRUCTIONS

## STEP-6

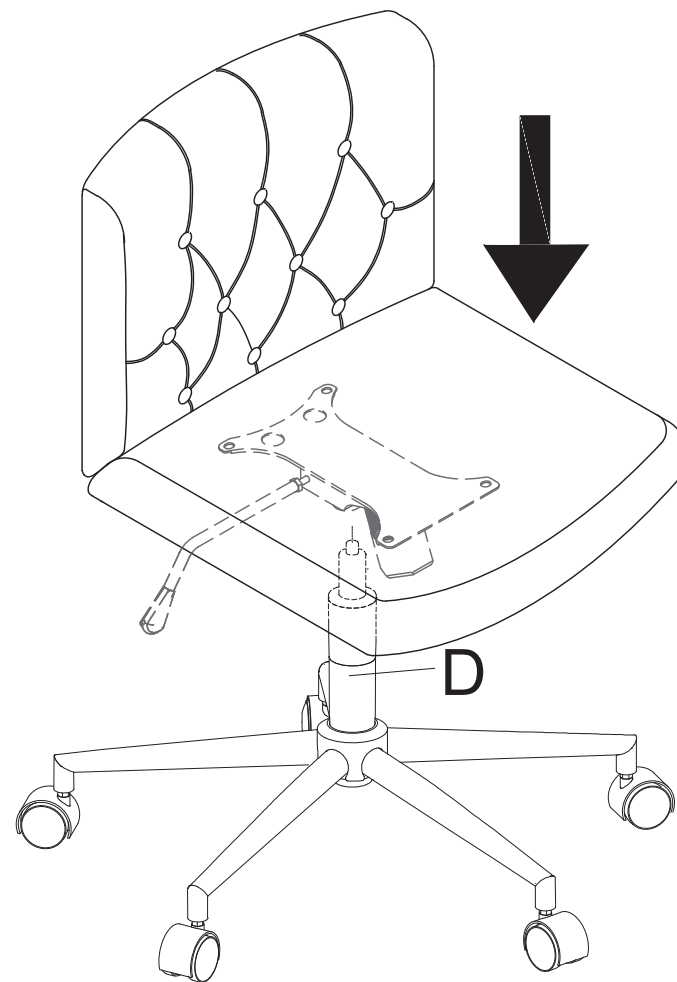

# ASSEMBLY INSTRUCTIONS

## STEP-7

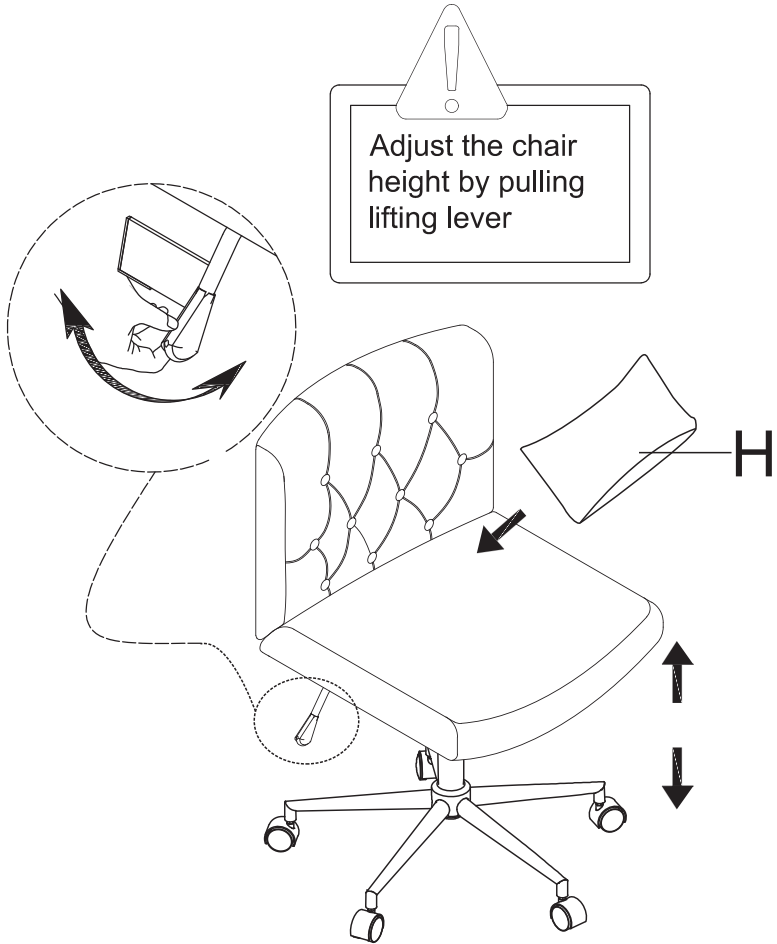

adjust forward and backward tilt angle of chair by rotating rotary knob under chair