

WARRANTY

We strive to offer high-quality products, and we also try our best to satisfy each and every customer that orders from us with product or service as needed. We provide 30 days warranty starting from the time you receive the item. Each customer must provide a record of their order such as the order number, or item receipt for any items that are out of the warranty period you may also still receive replacement parts by purchasing them with our company if they are available.

**Are you having difficulty
with assembly? Missing parts?**

**Please send email with your order No
customerservice@hulalahome.com**

**For return, Please check the return policy with
the retailer or MarketPlace you bought from.**

**Appreciated your purchasing from us.
Pop up your life by our furniture piece!**

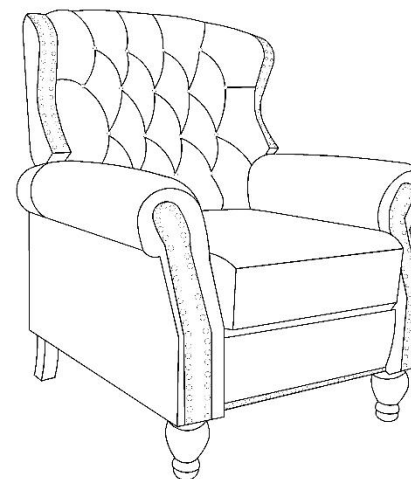

ITEM NO. RCXA0346

NOTE:

This brochure contains IMPORTANT safety info. Please read and keep for future reference.

MAINTAINANCE AND WARNING

- Keep furniture away from heat.
- Do not clean furniture with harsh cleansers or polish. Do not use detergents, Solvents, abrasives, spray packs or leather cleaner. Use non-color mild soap with warm water clean spills(Mix 1:10 soap to water)
- Do not place furniture under direct sunlight, material will possibly fade over time.
- Do not use on site dry Cleaning machine.
- Children should not climb or jump on the furniture.
- Do not write on furniture without a padded barrier to protect the surface.
- Not for commercial use, For residential use only.



Weight Limitation

250LBS

PARTS LIST

A*1 (Seat)

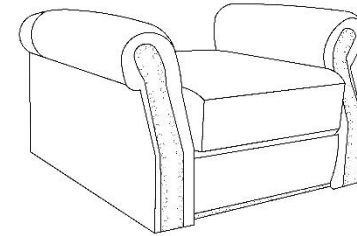

B*1 (Backrest)

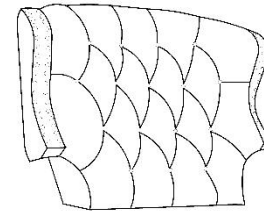

PARTS LIST

C*2(Back leg)

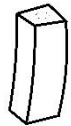

D*2(Front leg)

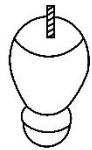

HARDWARE LIST

①*2



M8*60mm

②*4

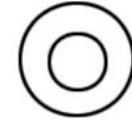

50mm

③*1



M8

④*2

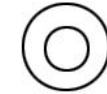

15 mm

SPARE

①*1



M8*60mm

②*1



50 mm

④*1

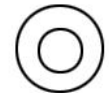

15 mm

Be sure to check all packing material carefully for small parts , which may have come loose inside the carton during shipment.

ASSEMBLY INSTRUCTIONS

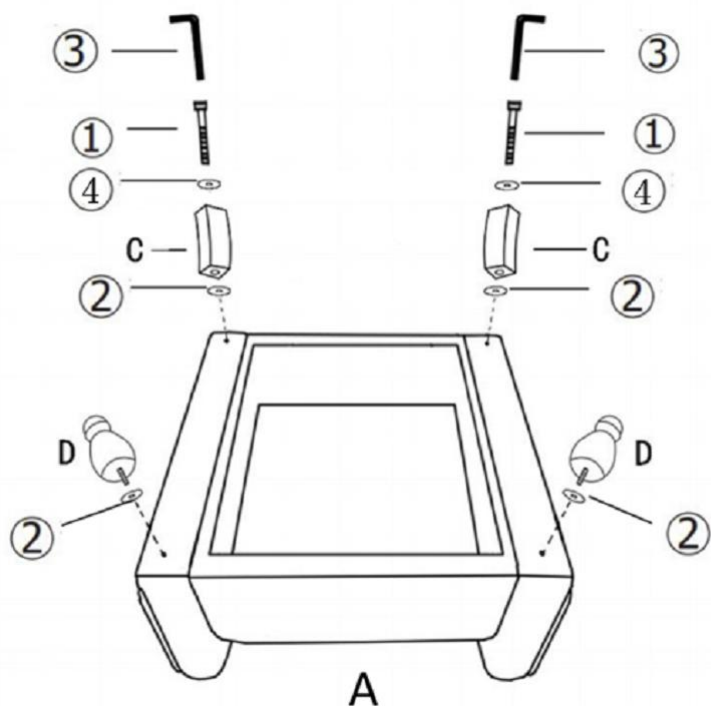

STEP 1: Use allen key ③ to attach bolt ①, rubber washers ④, legs C with rubber washers ② to bottom of the sofa base A, turn to fasten all legs. Attach legs D with rubber washers ② to bottom of the sofa base A, turn to fasten all legs.

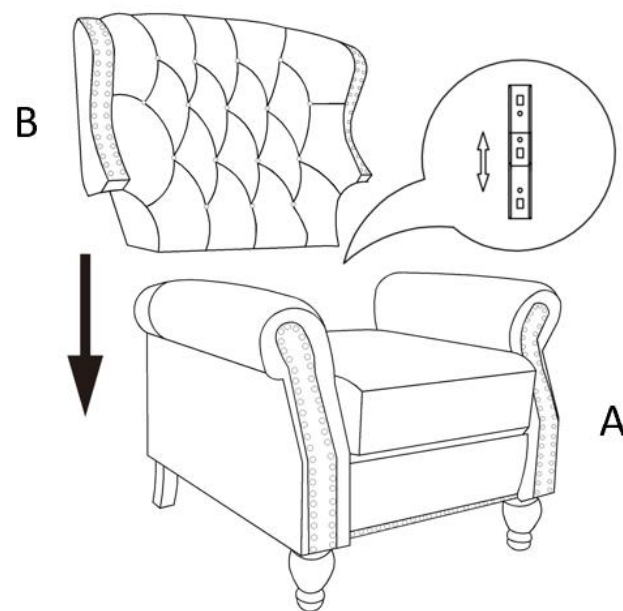

STEP 2: Carefully align male and female metal bracket then push the back B all the way down to secure with chair base A .

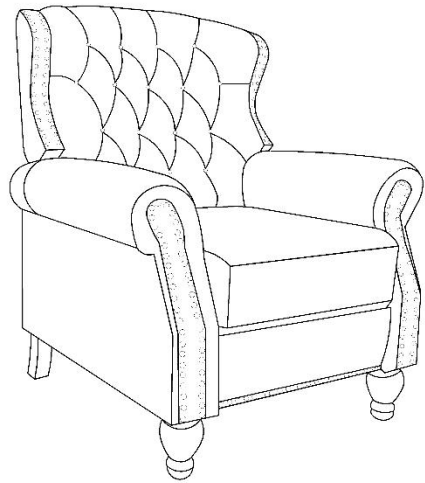

Assembly completed

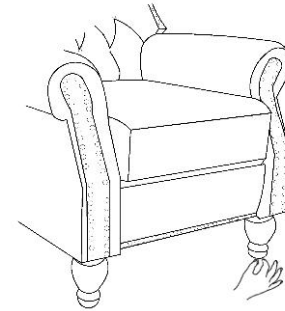

Attention:
After installation, adjust the
adjustable leveler to keep
the chair balanced.

Care & Maintenance

Upright position

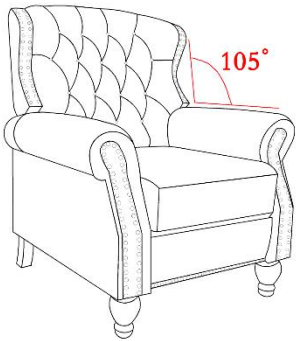

Full reclined position

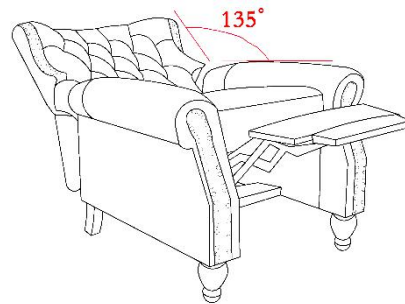

STEP 3: Push the back to stretch the chair reclined and press footrest to set it back to upright position.

- Furniture may scratch floors. We recommend using furniture pads to protect your floors.
- Do not put hot items directly on furniture surface.
- Do not clean furniture with harsh cleansers or polish.
- Do not place furniture under direct sunlight.
- Do not place furniture near heating or cooling vents.
- Do not write on furniture without a padded barrier to protect the surface.
- Do not place furniture outside . For indoor use only.
- Not for commercial use. For residential use only.
- Stains may be removed with mild soap solution and damp cloth.
- Children should not climb or jump on the furniture.
- Dust and pick-up spills using a clean, non-colored, lint-free cloth.
- According to your own usage, check the condition of the screws regularly, and lock them in time if they are found to be loose.
- If any parts are missing, broken, damaged or worn, stop using this product immediately until repairs are made using factory.