

HULALA

H O M E

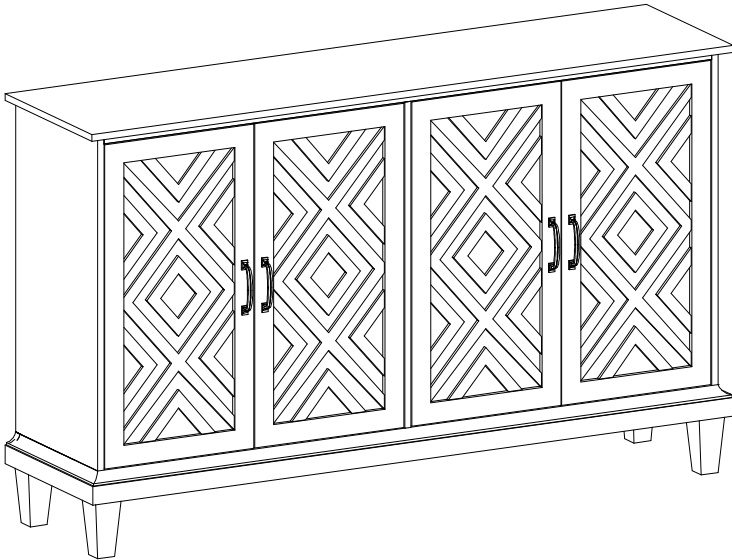

ITEM NO.SBTY0656

NOTE:

This brochure contains IMPORTANT safty info. Please read and keep for future reference.

MAINTAINANCE AND WARNING

- Keep furniture away from heat sources.
- Do not clean furniture with harsh cleaner or polishes. Do not use detergents, Solvents, abrasives, spray packs or leather cleaner. Use non-color mild soap with warm water to clean spills (Mix 1:10 soap to water)
- Do not place furniture under direct sunlight, material will possibly fade over time.
- Do not use on site dry Cleaning machine. Children should not climb or jump on the furniture.
- Do not write on furniture that is not protected by a padded barrier .
- Not for commercial use, only for residential use.



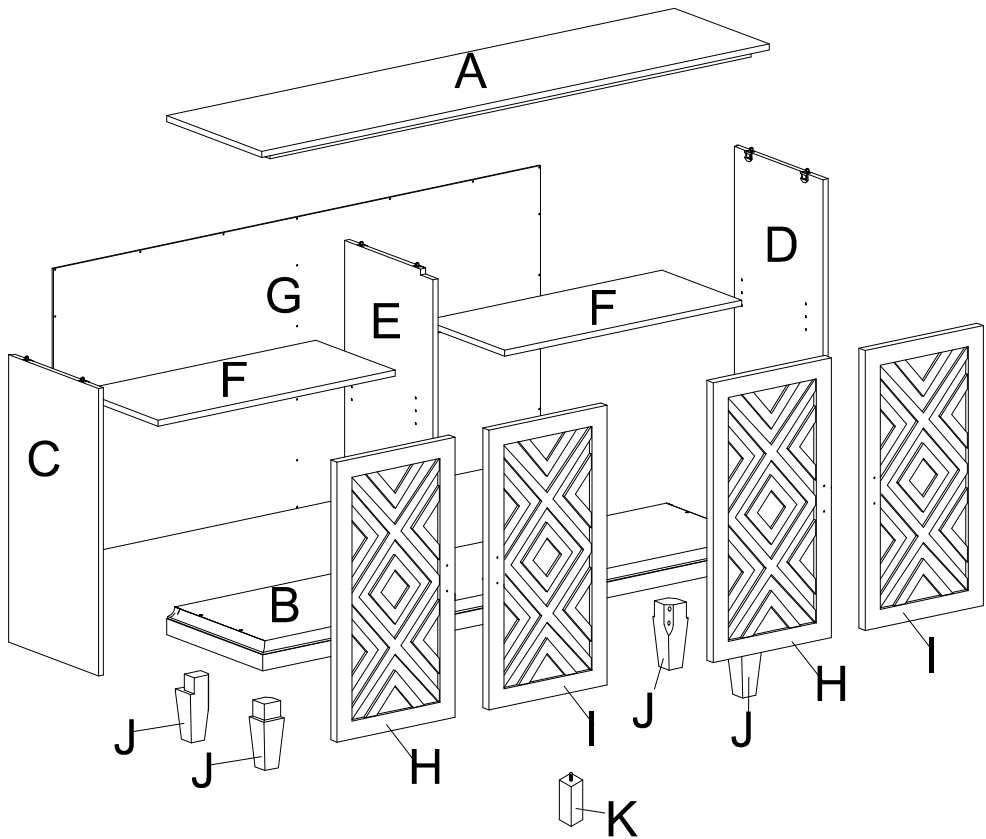

Weight Limitation

100LBS



OVERVIEW

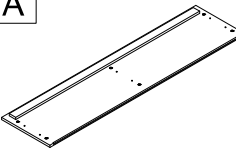
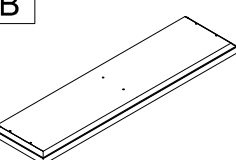
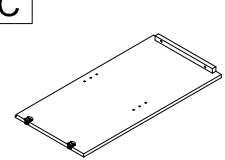
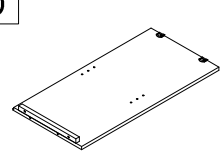
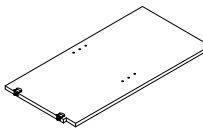
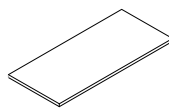
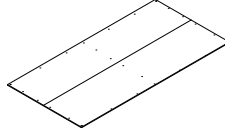
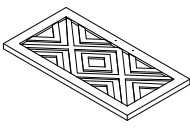
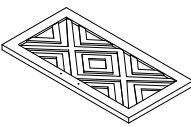



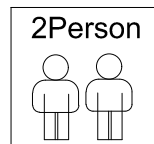

HARDWARE LIST

A 	B 	C 	D 
1 PC	1 PC	1 PC	1 PC
E 	F 	G 	H 
1 PC	2 PCS	1 PC	2 PCS
I 	J 	K 	
2 PCS	4 PCS	1 PC	





Persons Required For Assembly:



PARTS LIST 1















①	x12	②	x56	③	x4	④	x8	⑤	x26
									
ø8*30mm		ø3*14mm		ø3*14mm		ø5*32*25mm		ø3*14mm	
⑥	x1								
									
4mm									

SPARE

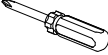
①	x1	②	x1	③	x1	④	x1	⑤	x1
									
ø8*30mm		ø3*14mm		ø3*14mm		ø5*32*25mm		ø3*14mm	





Be sure to inspect all packing material carefully for small parts, that may have come loose inside the carton during shipment.

PARTS LIST 2

⑦	x8	⑧	x6	⑨	x2	⑩	x8	⑪	x8
									
φ4/1"*50mm		φ4/1"*32mm		L72*D17					
⑫	x4	⑬	x14	⑭	x14	⑮	x1	⑯	x2
									
		φ4/1"		φ4/1"*16mm					
⑰	x1	⑱	x1	⑲	x1	⑳	x1		
									

Be sure to inspect all packing material carefully for small parts, that may have come loose inside the carton during shipment.



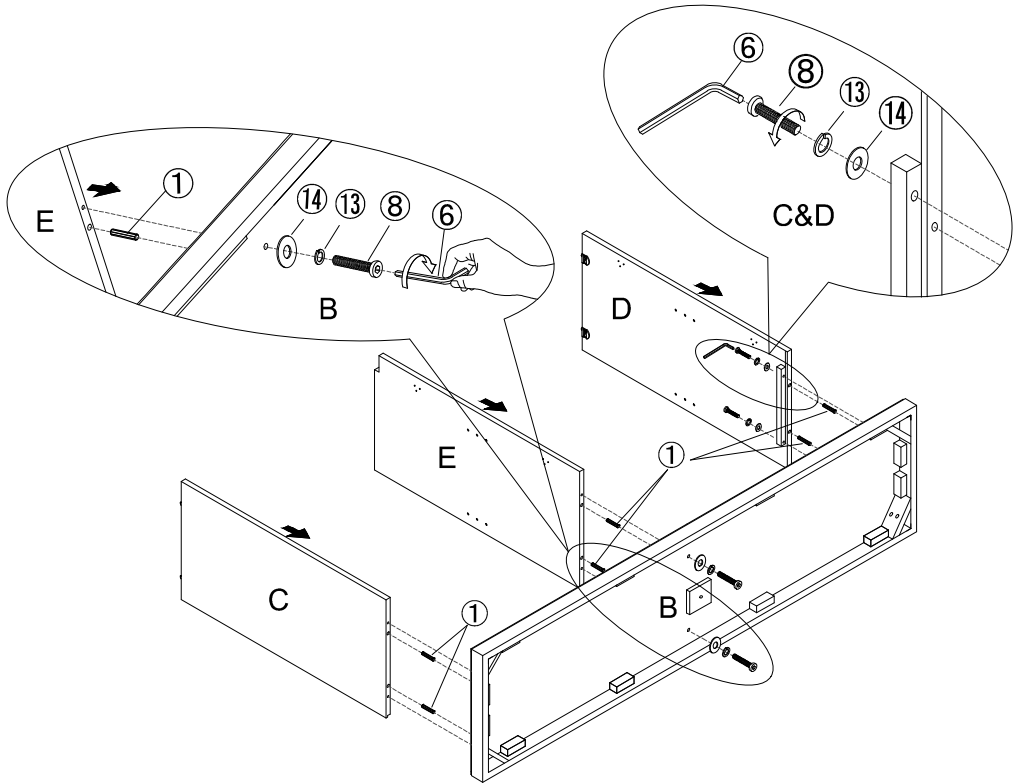

ASSEMBLY INSTRUCTIONS

①	x6	⑥	x1	⑧	x6	⑬	x6	⑭	x6
									
$\phi 8*30\text{mm}$		4mm		$\phi 4/1''*32\text{mm}$		$\phi 4/1''*16\text{mm}$		$\phi 4/1''$	



STEP1:

Insert wooden dowel ① into the corresponding hole of bottom panel (B), and then insert panel (C)&(E)&(D) into bottom panel(B),use plat washer ⑭、spring washer⑬& bolt⑧ to attach panel(C)&(E)&(D) to bottompanel (B), tighten bolt⑧ with allen key⑥

⑥	x1	⑦	x8	⑬	x8	⑭	x8
							
4mm		φ4/1"×50mm		φ4/1"×16mm		φ4/1"	

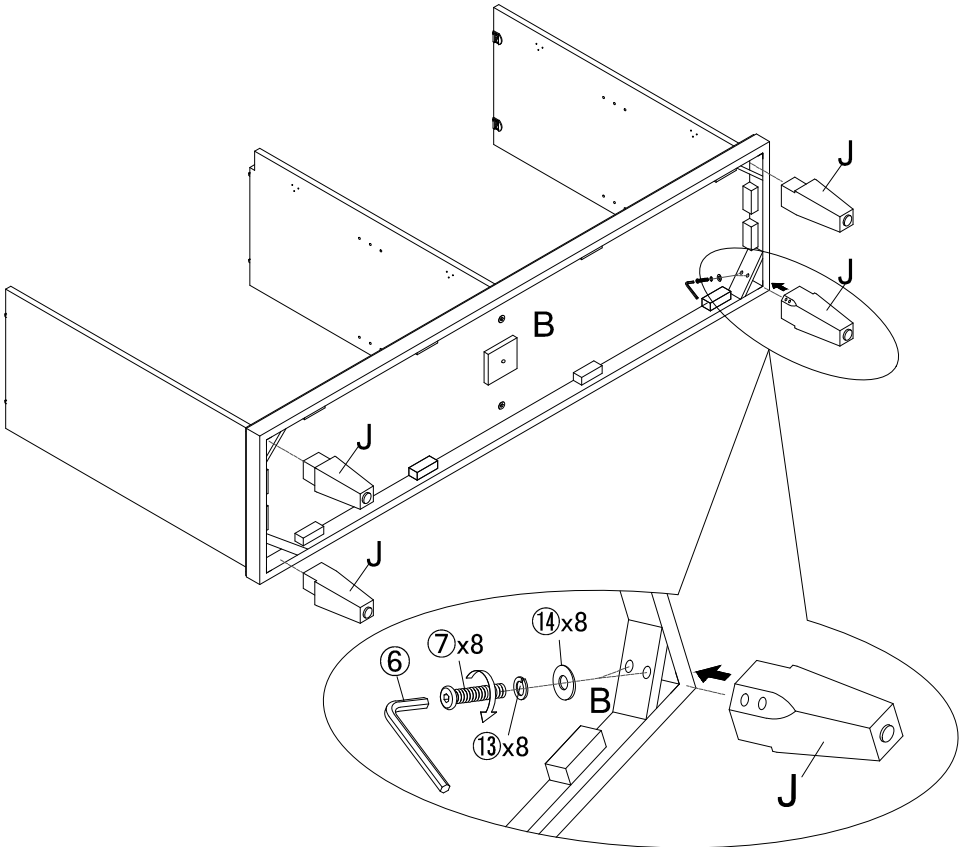

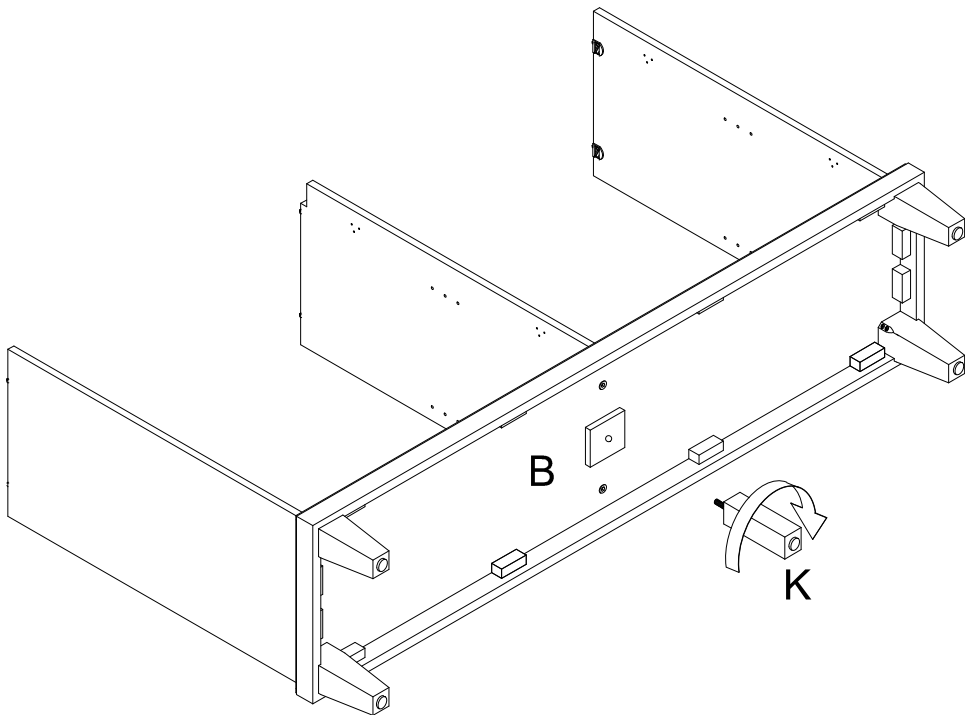

STEP2:

Insert leg(J) into the corresponding position of bottom panel (B),and then use plat washer ⑭、spring washer ⑬& bolt ⑦ to attach leg (J) to bottom panel (B),tighten bolt ⑦ with allen key⑥



STEP3:

Screw leg (K) into the corresponding hole of bottom panel (B).

⑨	x2	⑮	x1	③	x4
					
L72*D17		ø3*14mm			

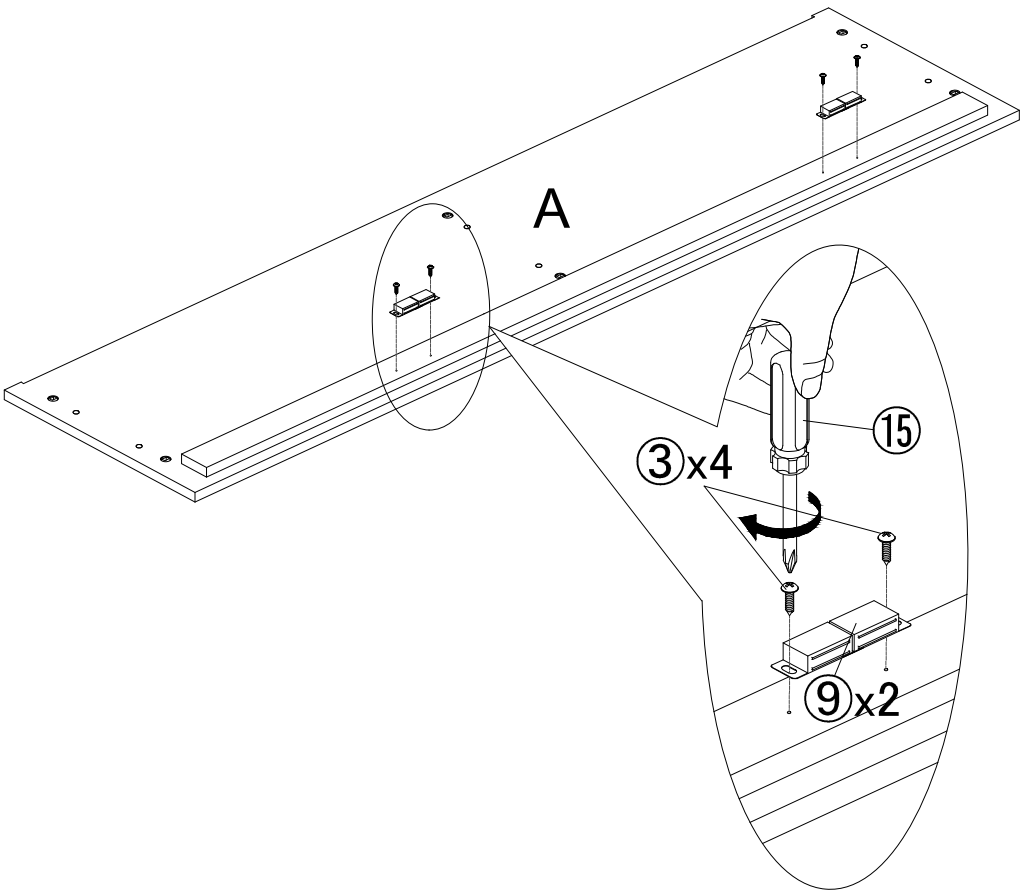

STEP4:

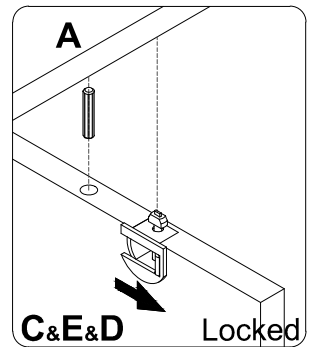
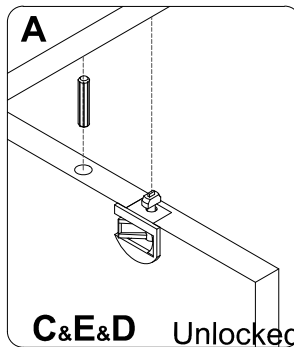
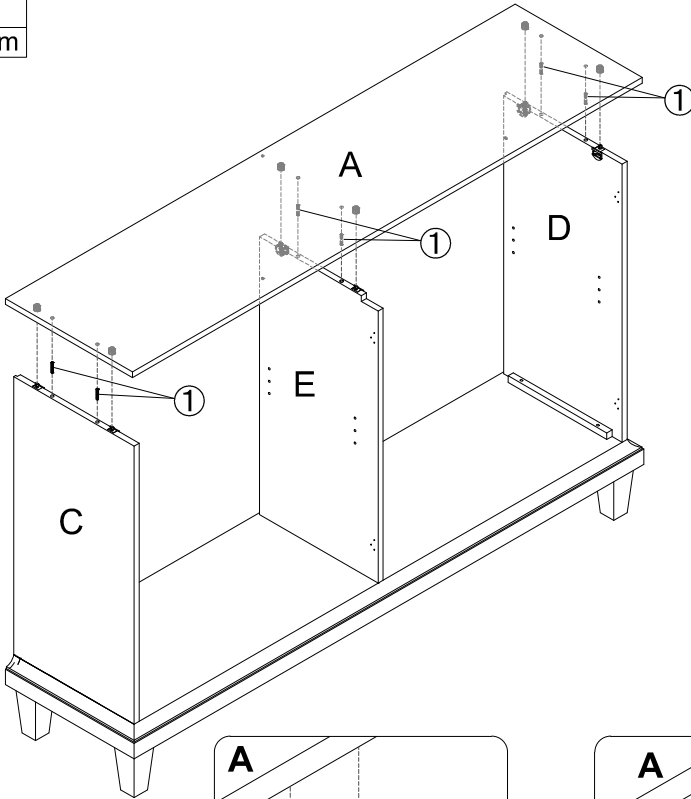

Use screw ③ to attach magnetic catch ⑨ to top panel (A) as picture show , tighten screw ③ with screwdriver ⑮.

①	x6
	
$\phi 8 \times 30 \text{mm}$	



STEP5:

Insert wooden dowel ① into the corresponding hole of panel(C)&(E)&(D), and then insert top panel(A) into the preassembly unit at step 3, make sure all holes aligned, finally pull the combiner to lock it.

⑮	x1	⑤	x26
			
φ3*14mm			

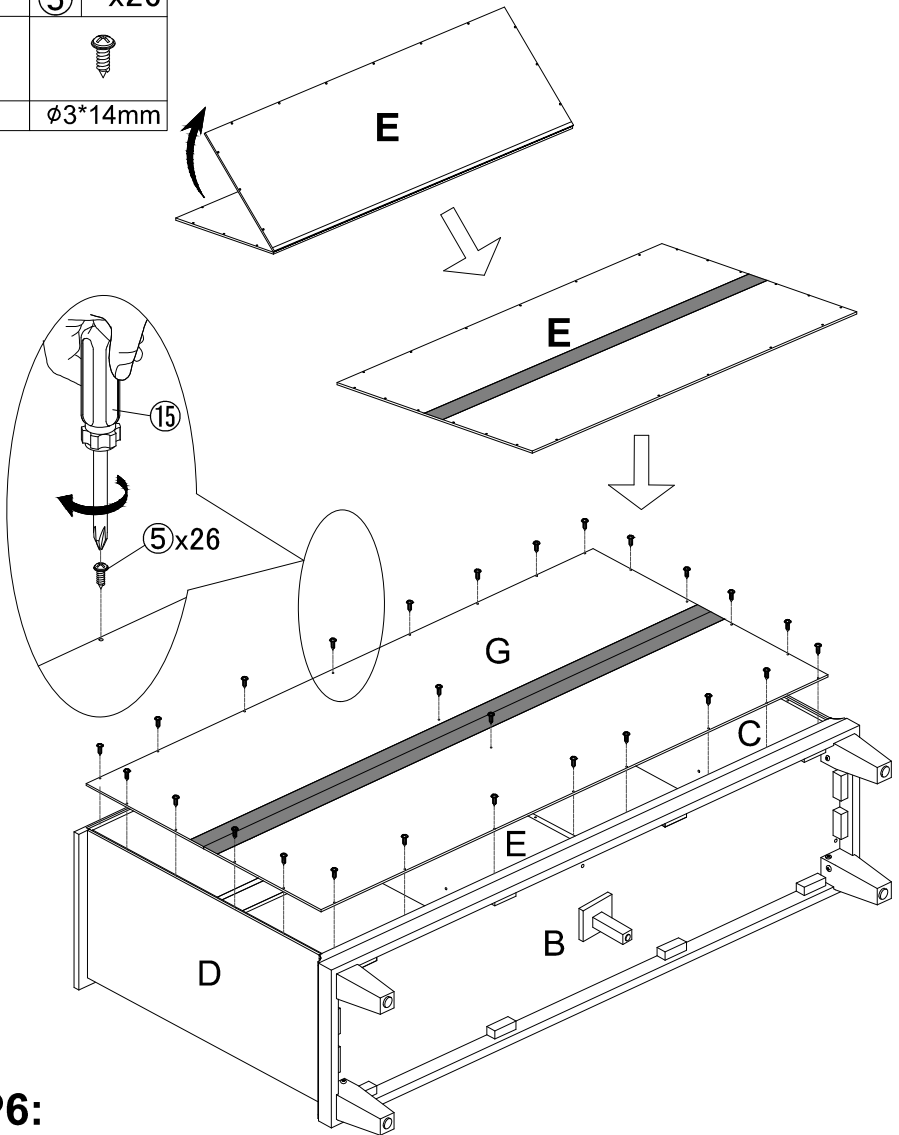



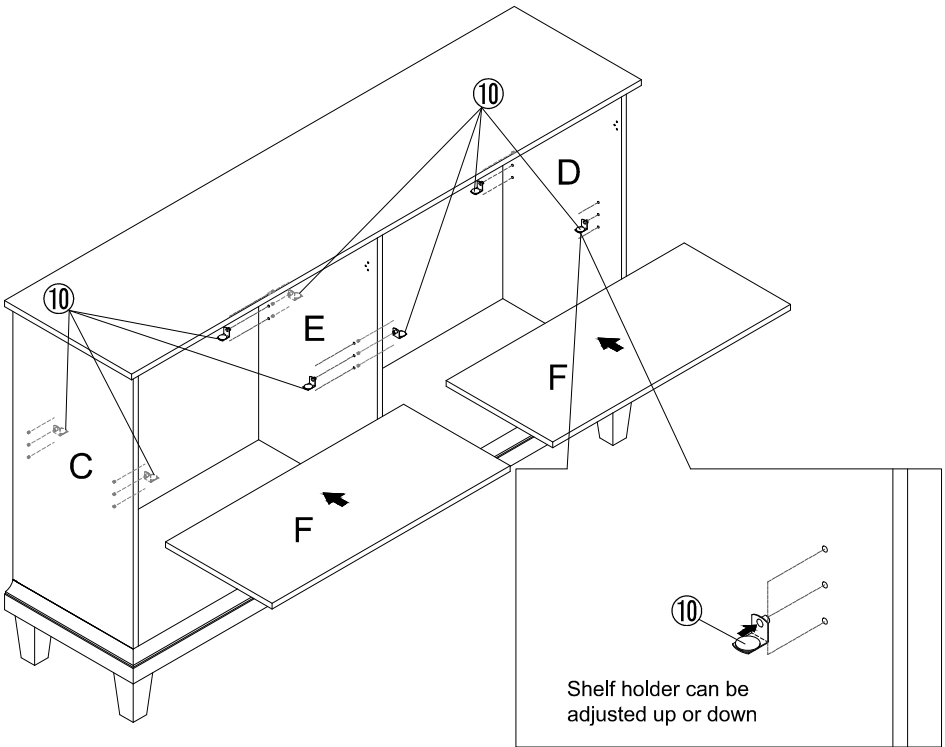
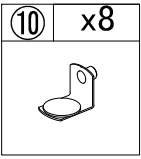

STEP6:

Insert back panel (G) into the groove of preassembly step 5, make sure all holes aligned , and then use screw ⑤ to attach back panel (G) to preassembly step 5, tighten screw ⑤ with screwdriver⑮.



STEP7:

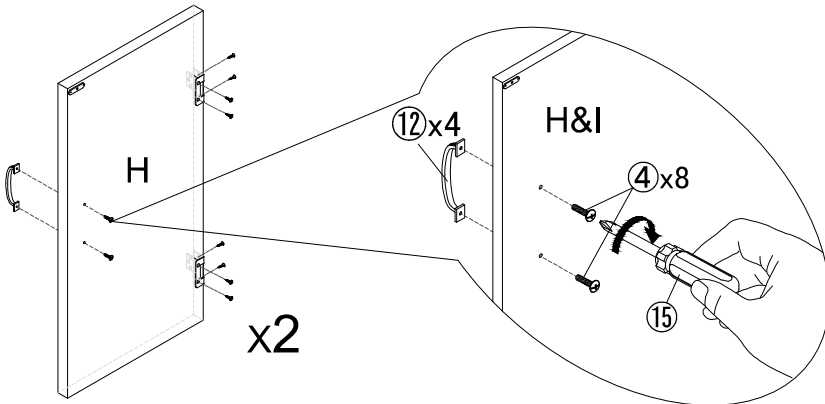
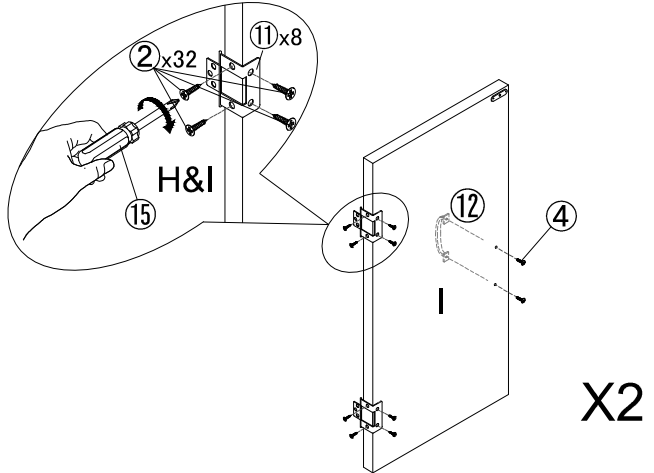

Insert shelf holder ⑩ into the corresponding hole of panel (C)&(E)&(D), make all shelf holder same level and then attach adjustable shelf (F) to it.

⑮	x1	②	x32	④	x8	⑫	x4	⑪	x8
									
		ø3*14mm		ø5*32*25mm					



STEP8:

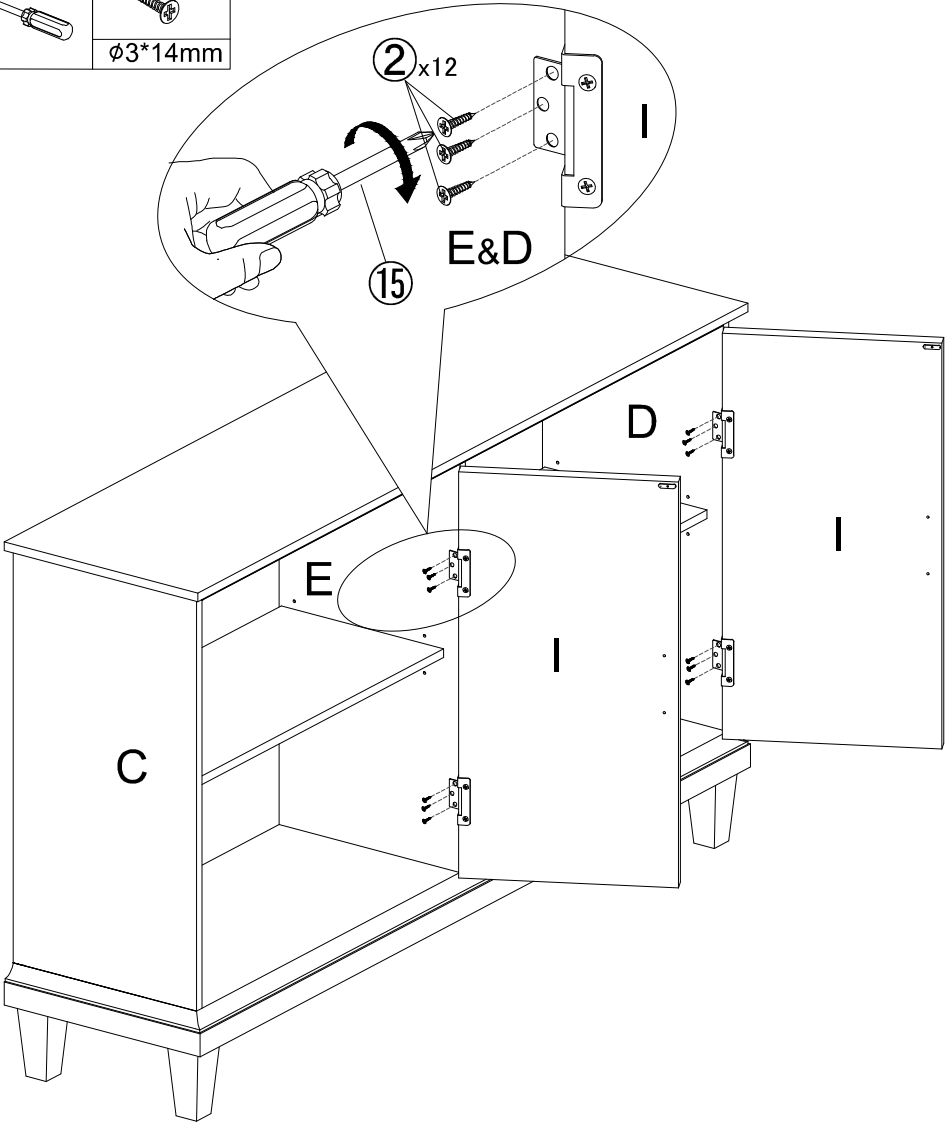

Use screw ④ to attach handle ⑫ to door (H)&(I),tighten screw ④ with screwdriver ⑮,and then use screw ② to attach hinge ⑪ to the corresponding position of door (H)&(I),tighten screw ② with screwdriver ⑮.

⑮	x1	②	x12
			
		ø3*14mm	



STEP9:

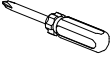

Use screw ② to attach door(I) to panel(E)&(D),tighten screw ② with screwdriver⑮.

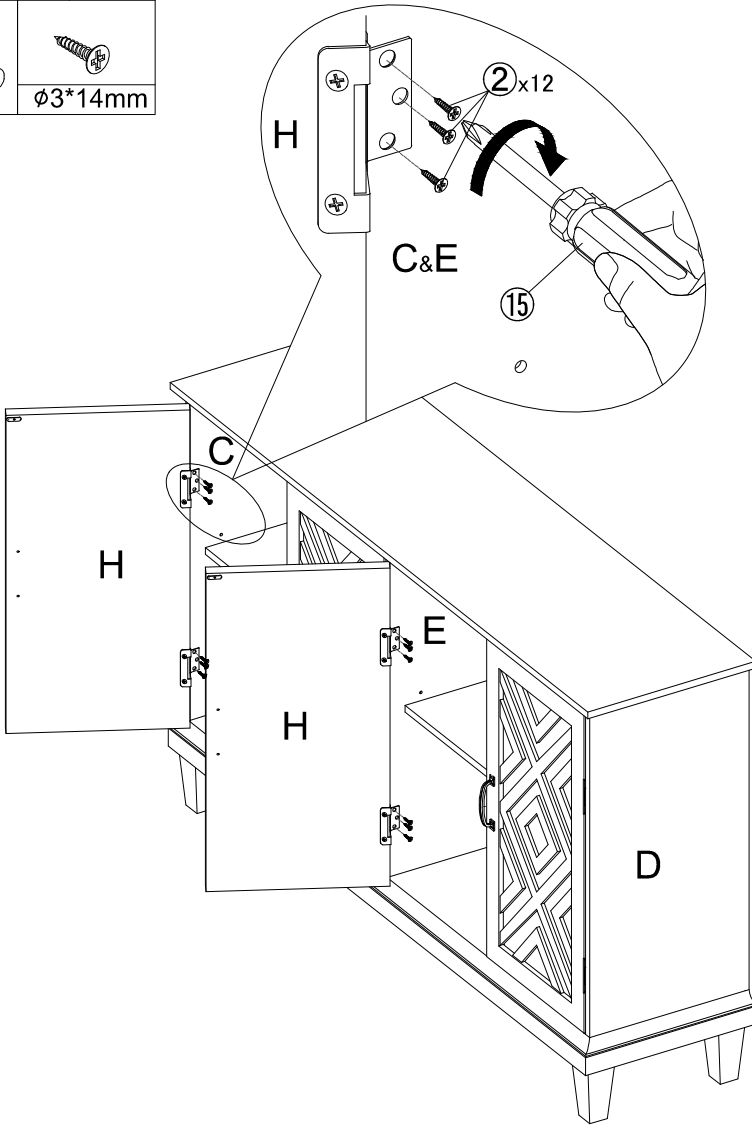
⑮	x1	②	x12
			
ø3*14mm			



STEP10:

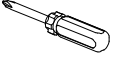

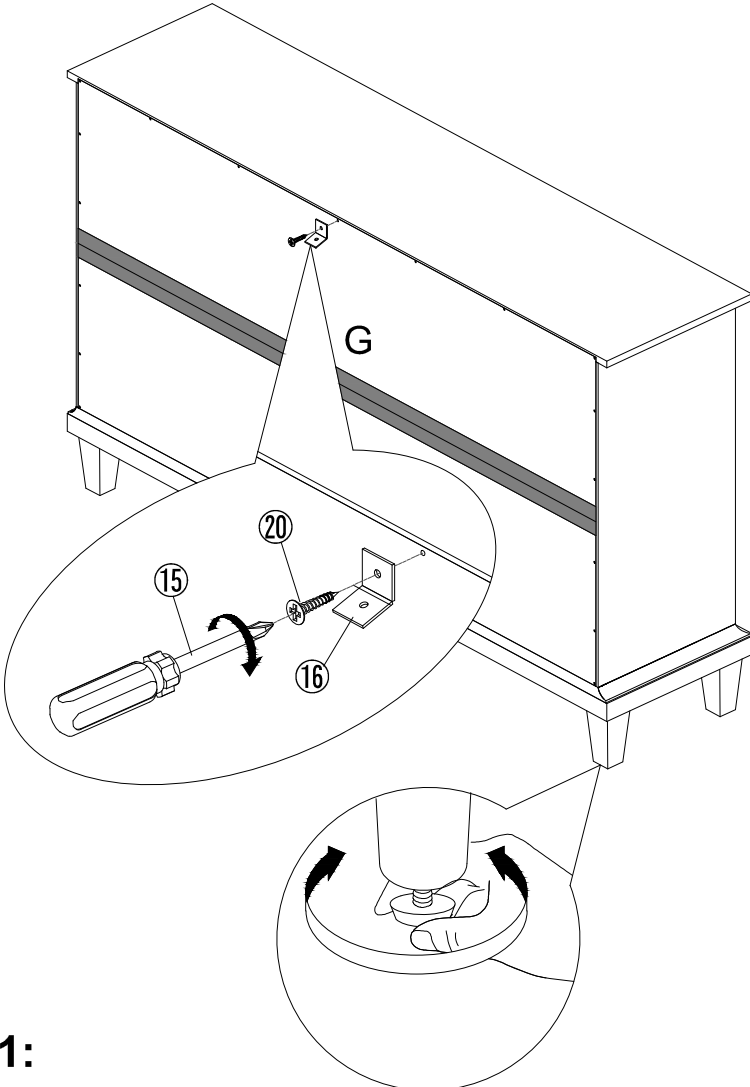

Use screw ② to attach door(H) to panel(C)&(E),tighten screw ② with screwdriver⑮.

⑮	x1	⑳	x1	⑰	x1
					

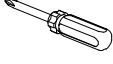

STEP11:

Use screw ⑳ to attach hinge⑰ to back panel(G),tighten screw⑳ with screwdriver⑮.

⑰	x1	⑲	x1	⑮	x1	⑯	x1
							

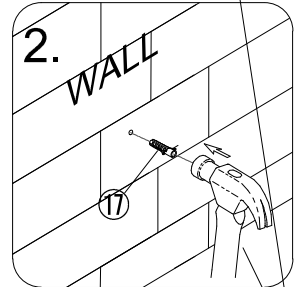
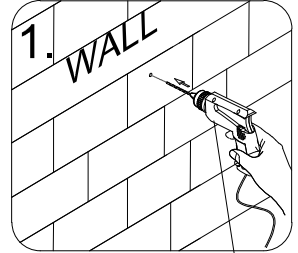
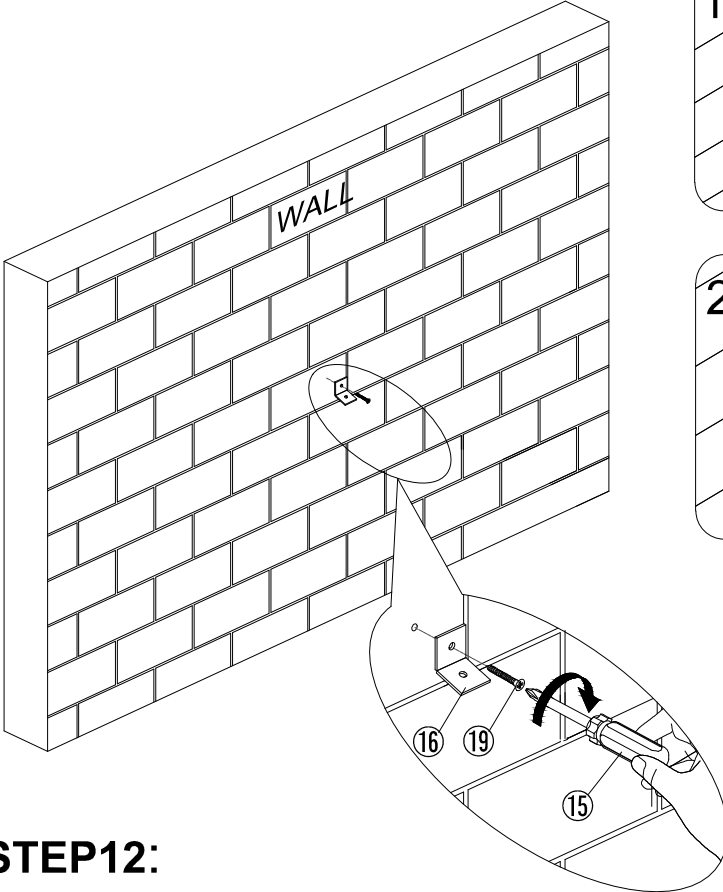

NOT PROVIDED

STEP12:

Mark the position on the wall, that corresponds to the location of hinge ⑯ on the back panel(G); Drill and insert the expandable screw ⑰ by hammer.

Assemble the hinge ⑯ to the wall. Align the hole in the hinge ⑯ with the expandable screw ⑰, use screw ⑲ to attach it, tighten screw ⑲ with screwdriver ⑮.

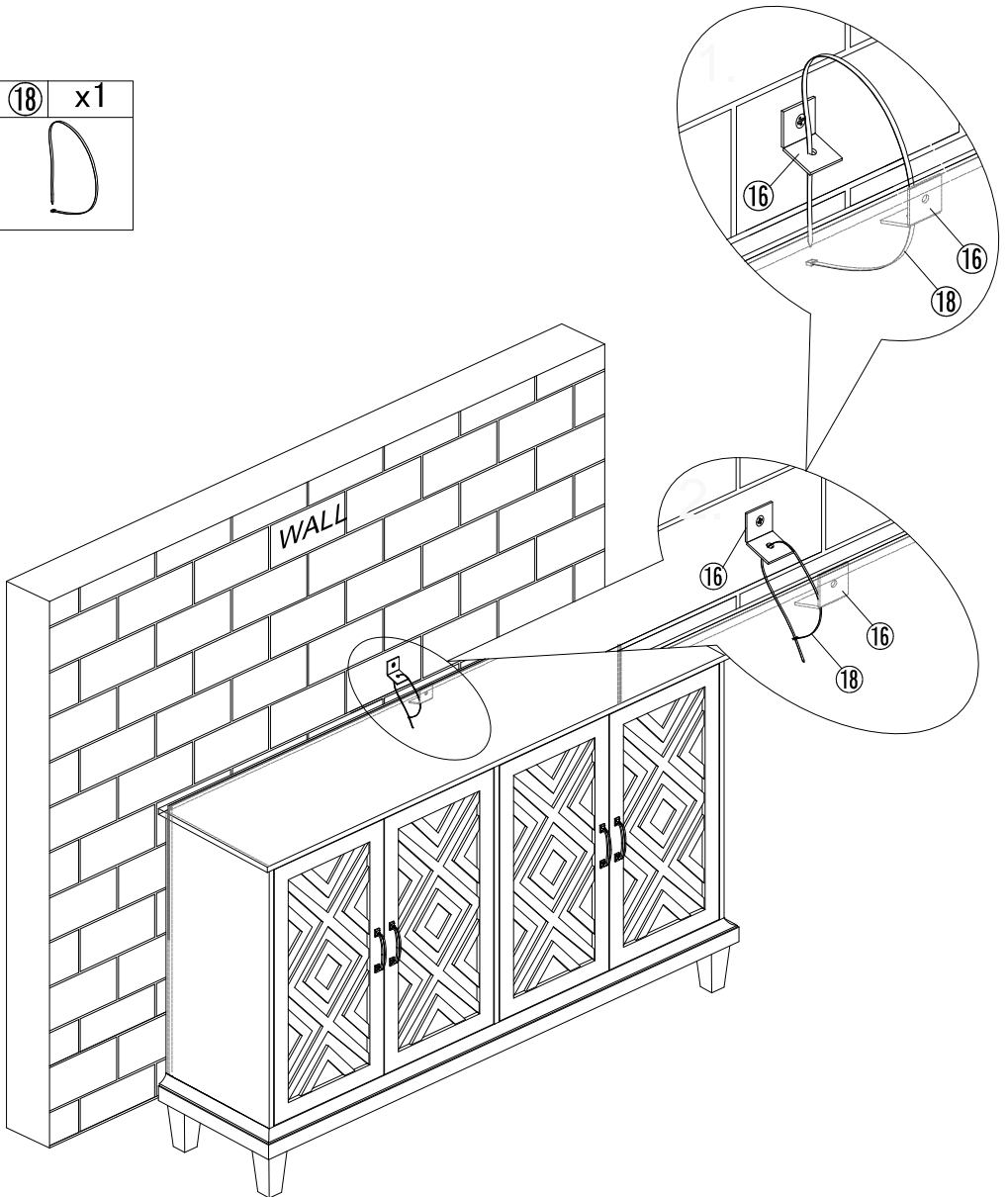
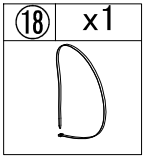

STEP13:

Let the plastic belt ⑱ pass through hinge ⑯ and pull tightly.

WARRANTY

We strive to offer high-quality products, and we also try our best to satisfy each and every customer that orders from us with product or service as needed. We provide 30 days warranty starting from the time you receive the item. Each customer must provide a record of their order such as the order number, or item receipt for any items that are out of the warranty period you may also still receive replacement parts by purchasing them with our company if they are available.

Are you having difficulty
with assembly? Missing parts?
Please send email with your order No to
customerservice@hulalahome.com
For return, please check the return policy with
the retailer or market place you bought from.

Appreciate your purchasing from us.
Pop up your life by our furniture piece!