

HULALA

H O M E

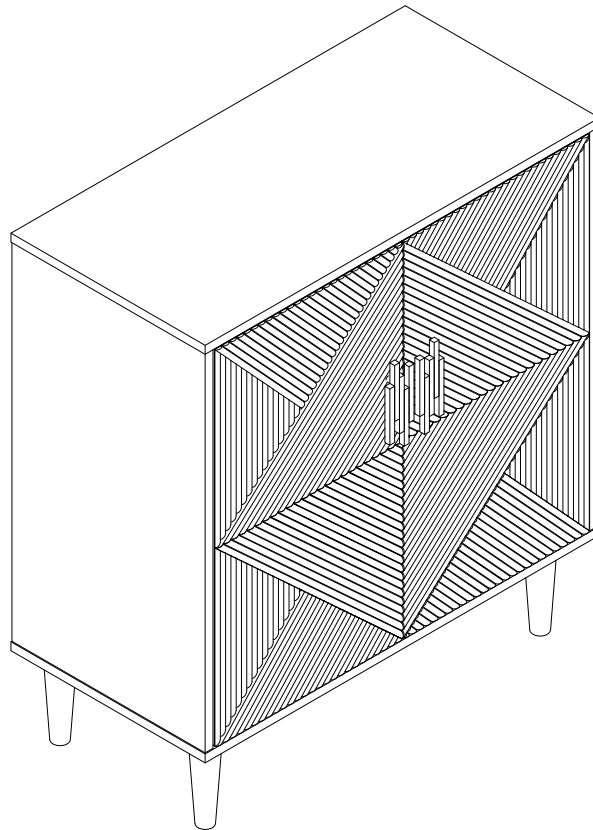

ITEM NO.SCTY0594

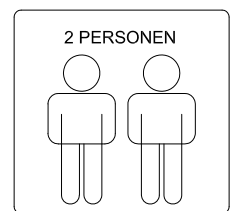

NOTE:

This brochure contains IMPORTANT safty info. Please read and keep for future reference.

MAINTAINANCE

AND WARNING

- Keep furniture away from heat.
- Do not clean furniture with harsh cleansers or polish. Do not use detergents, Solvents, abrasives, spray packs or leather cleaner. Use non-color mild soap with warm water clean spills(Mix 1:10 soap to water)
- Do not place furniture under direct sunlight, material will possibly fade over time.
- Do not use on site dry Cleaning machine.
- Children should not climb or jump on the
- Do not write on furniture without a padded barrier to protect the surface.
- Not for commercial use, For residential use

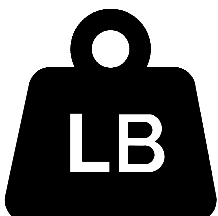

Weight Limitation

100LBS

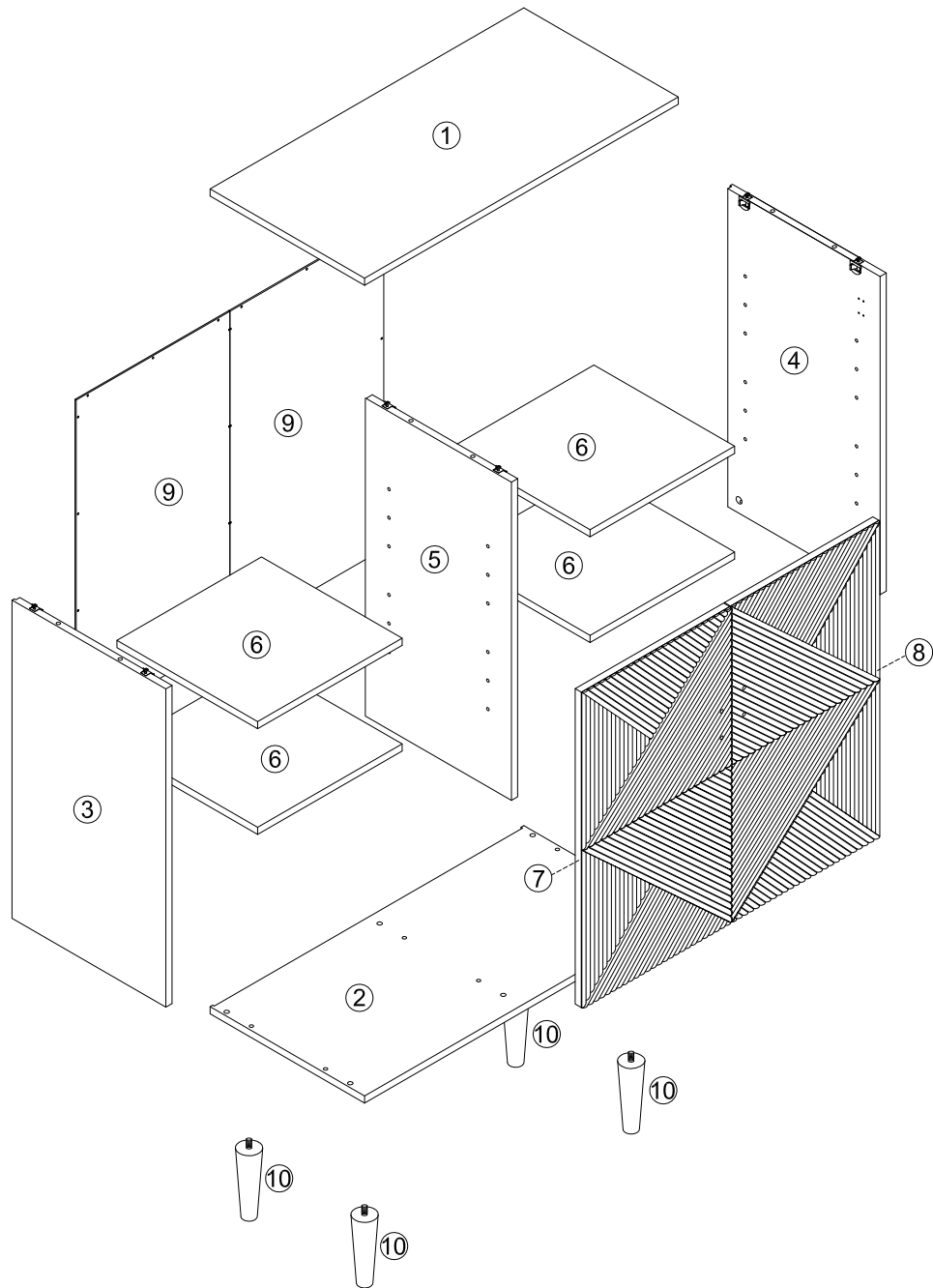

OVERVIEW

PARTS LIST

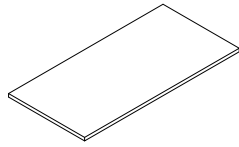

①x1

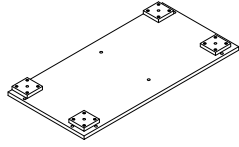

②x1



③x1

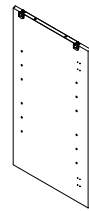

④x1

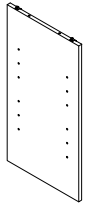

⑤x1

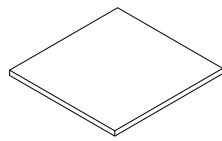

⑥x4

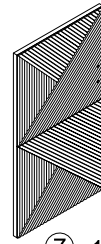

⑦x1

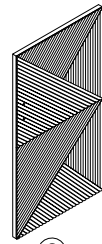

⑧x1

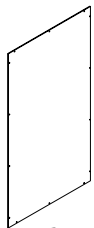











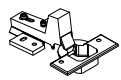



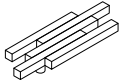

⑨x2











⑩x4

HARDWARE LIST

A	x12	B	x16	C	x24	D	x4	E	x24	F	x6	G	x6	H	x6
															
Ø8*30mm				Ø3*14mm		Bend Hinge		Ø3.5*14mm		Ø1/4"x1-1/4"		Ø1/4"		Ø1/4"x16mm	
I	x1	J	x2	K	x4	L	x1	M	x2	N	x1	O	x1	P	x1
															
M4				Ø1/4"x1"						Ø3*15mm		Ø3*38mm		Safety Wall Strap	
Q	x1														
															

SPARE

A	x1	B	x1	C	x1	E	x1	F	x1	G	x1	H	x1	K	x1
															
Ø8*30mm				Ø3*14mm		Ø3.5*14mm		Ø1/4"x1-1/4"		Ø1/4"		Ø1/4"x16mm		Ø1/4"x1"	

Be sure to check all packing material carefully for small parts, which may have come loose inside the carton during shipment.

ASSEMBLY INSTRUCTIONS

Please do not use tools to assemble this unit unless specifically indicated.

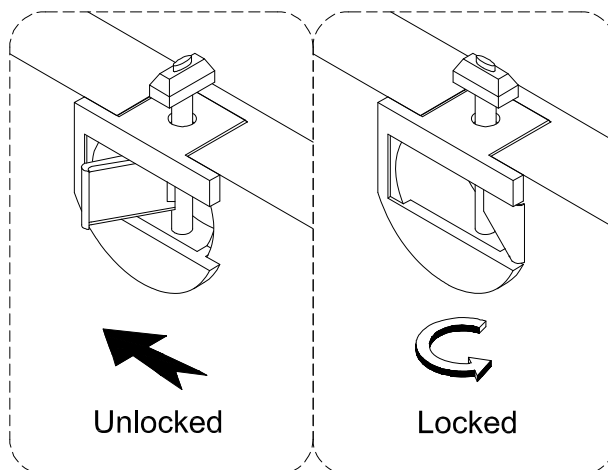

Reference the images above any time the instructions state "lock the hardware".

Note: Be sure to check all hardware is locked when completed.

STEP 1

Prepare the part 2 and 10. Align the hole in part 10 to the hole in part 2 tighten it by hand.

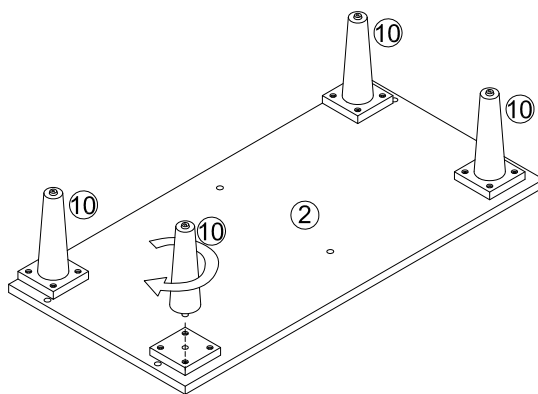



ASSEMBLY INSTRUCTLONS

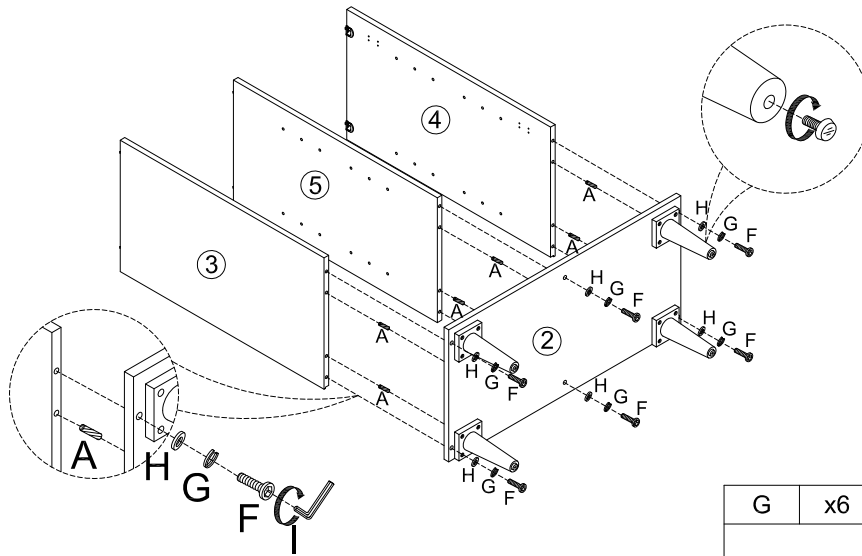

STEP 2

Prepare the parts 2,3,4,5.

Attach bottom panel 2 to assembled unit 3, 4, 5 using wooden dowels A, bolts F, spring washers G, flat washers H and allen wrench I.



A	x6	F	x6
			
Ø8*30mm		Ø1/4"x1-1/4"	

G	x6	H	x6	I	x1
					
Ø1/4"		Ø1/4"x16mm		M4	

STEP 3

Prepare the parts 1.

Attach top panel 1 to assembled unit 3, 4, 5 using wooden dowels A and lock the hardware.

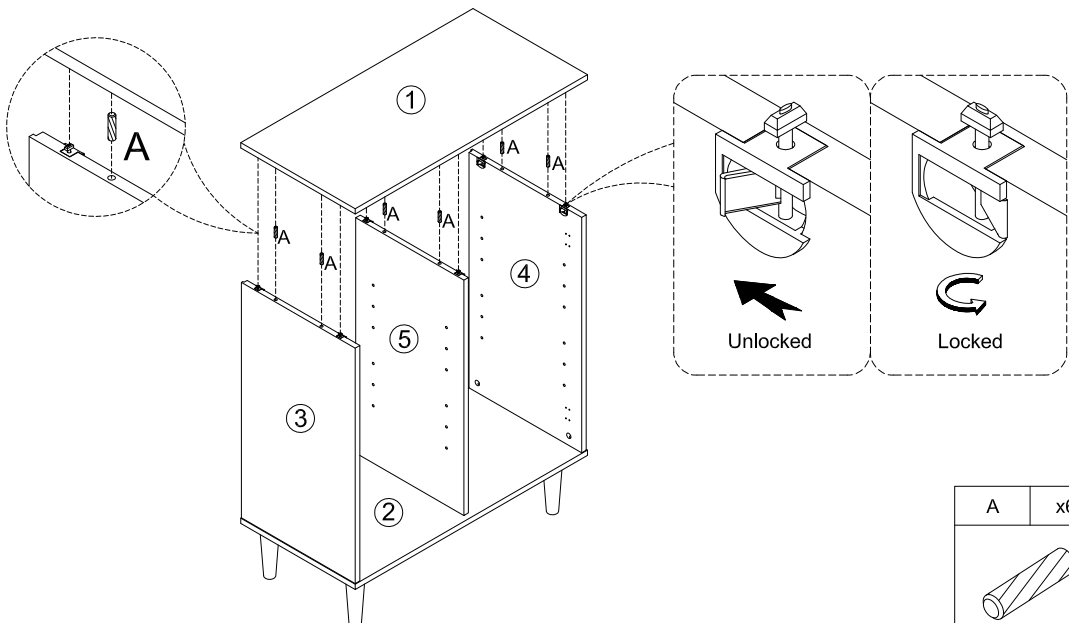

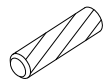
A	x6
	
Ø8*30mm	



ASSEMBLY INSTRUCTLONS

STEP 4

Prepare the parts 9.

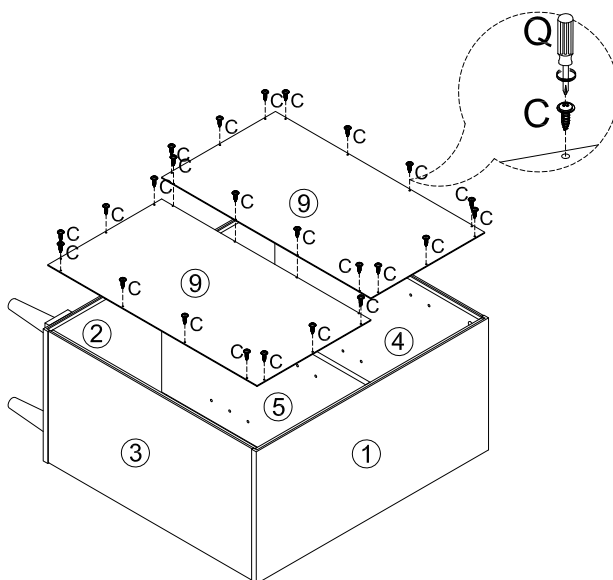
Attach back panel 9 to assembled unit 1, 2, 3, 4, 5 using screws C and phillips head screwdriver.





C	x24	Q	x1
			
Ø3*14mm			

STEP 5

Prepare the parts 6.

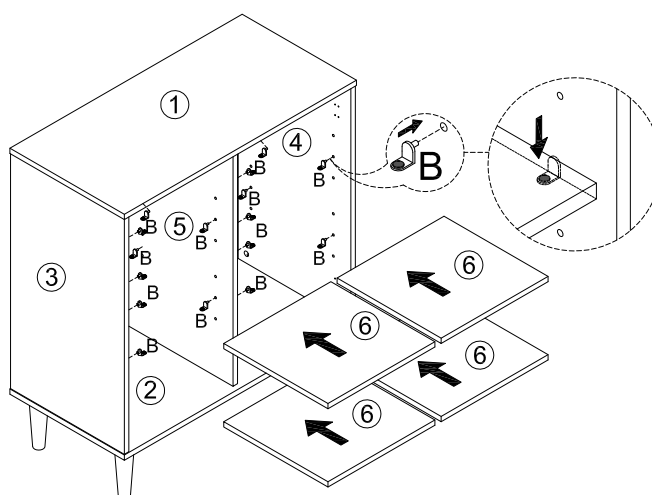
Place shelf holders B into desired position and slide adjustable shelves 6 into place.



B	x16
	

ASSEMBLY INSTRUCTLONS

STEP 6

Prepare the parts 7, 8.

- 1) Use the screwdriver and screw E to attach part D to part 7, 8, make sure all holes aligned and tighten all screws to secure.
Use the allen key I and screws K to attach part J to part 7, 8, make sure all holes aligned and tighten all screws to secure .

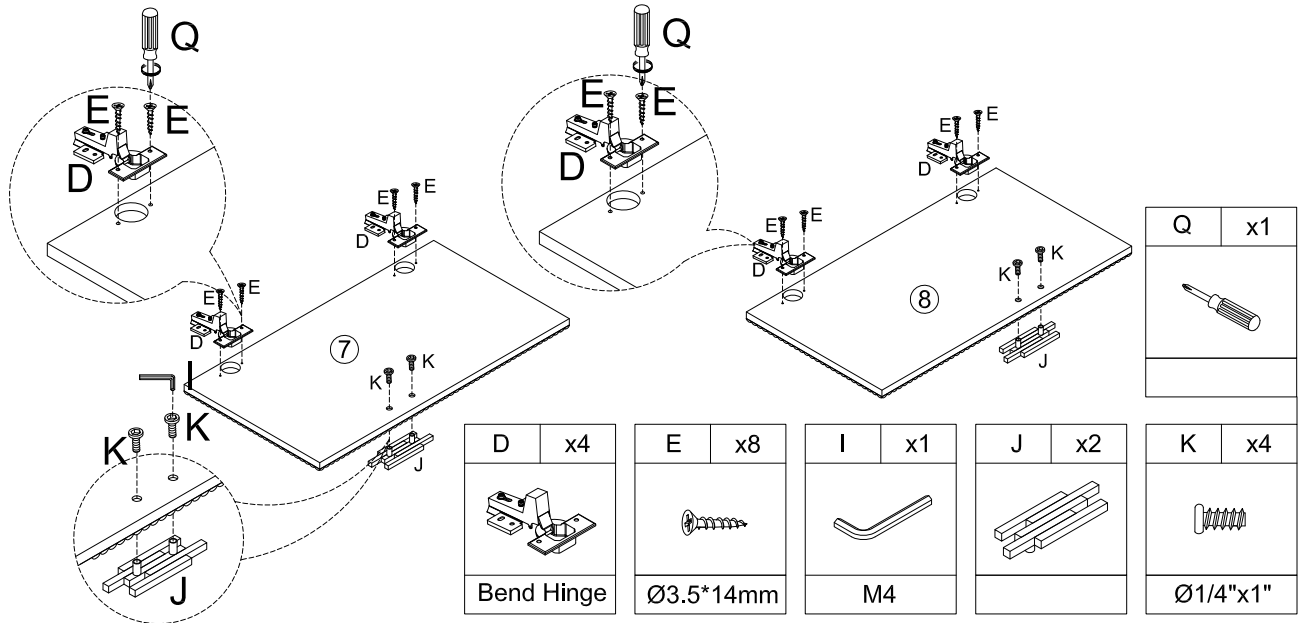

STEP 7

Prepare the parts 7, 8.

Attach doors 7, 8 to panels 3, 4 using screws E and phillips head screwdriver.

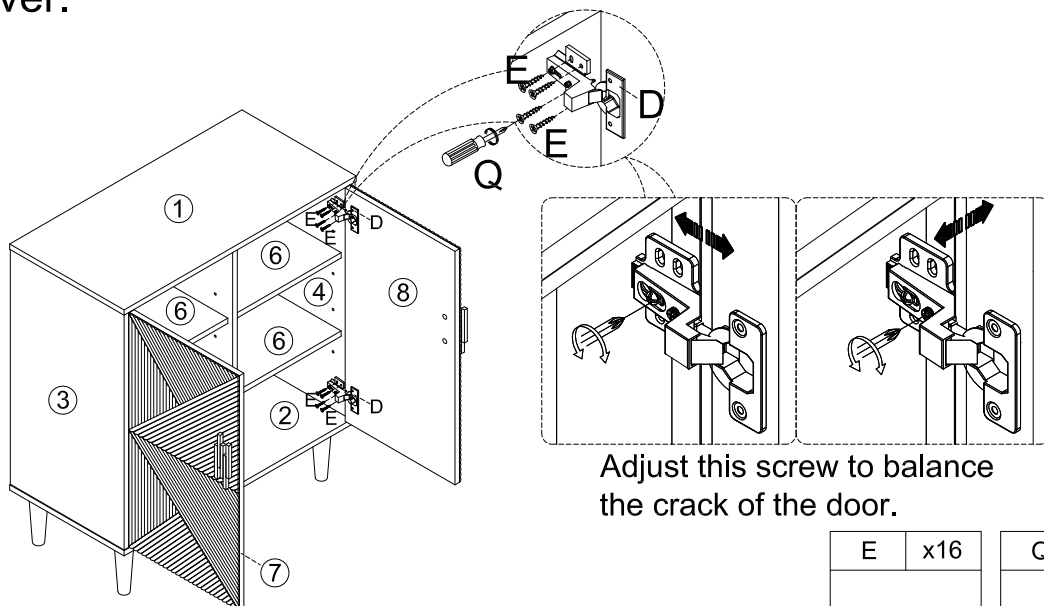

E	x16	Q	x1
Ø3.5*14mm			

ASSEMBLY INSTRUCTLONS

STEP 8

Install the anti-collapse device.

1. Mark the position on the wall, this should be the same as the position of M where are on the back of panel 1; Drilled and insert the expandable screw L by hammer;
2. Assemble the part M on the wall. Align the hole in the part M to the expandable screw L, Screw in screw O and tighten with screwdriver Q.
3. Use the screwdriver Q and screws N to attach the part M to panel 1 make sure all holes aligned and tighten all screws N to secure.
4. let the plastic belt P go through the both M and pull to tighten.

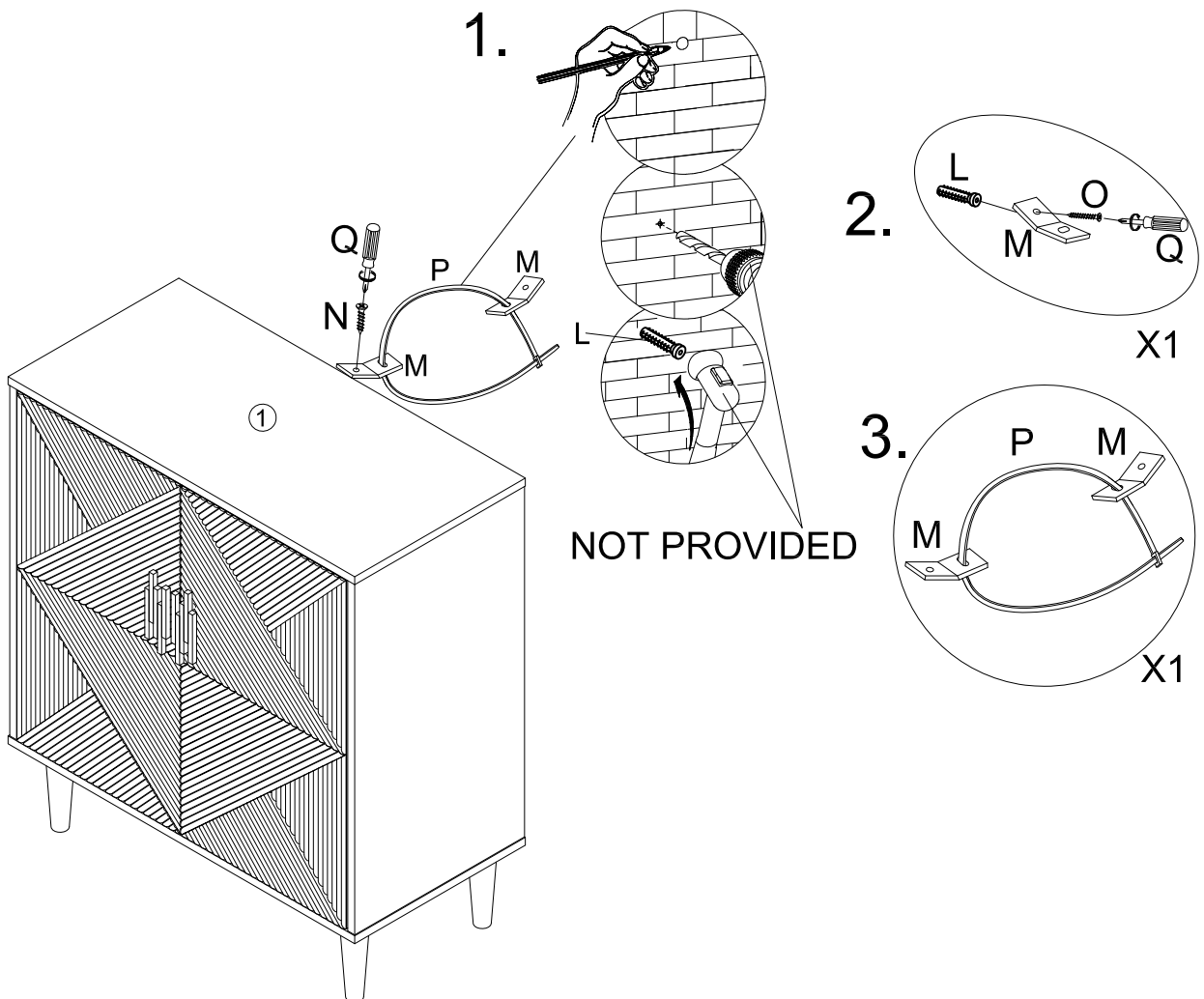



L	x1
	

M	x2
	

N	x1
	
Ø3*15mm	

O	x1
	
Ø3*38mm	

P	x1
	
Safety Wall Strap	

Q	x1
	

WARRANTY

We strive to offer high-quality products, and we also try our best to satisfy each and every customer that orders from us with product or service as needed. We provide 30 days warranty starting from the time you receive the item. Each customer must provide a record of their order such as the order number, or item receipt for any items that are out of the warranty period you may also still receive replacement parts by purchasing them with our company if they are available.

Are you having difficulty
with assembly? Missing parts?

Please send email with your order No

customerservice@hulalahome.com

For return, Please check the return policy with
the retailer or MarkeyPlace you bought from.

Appreciated your purchasing from us..
Pop up your life by our furniture piece!