

HULALA

H O M E

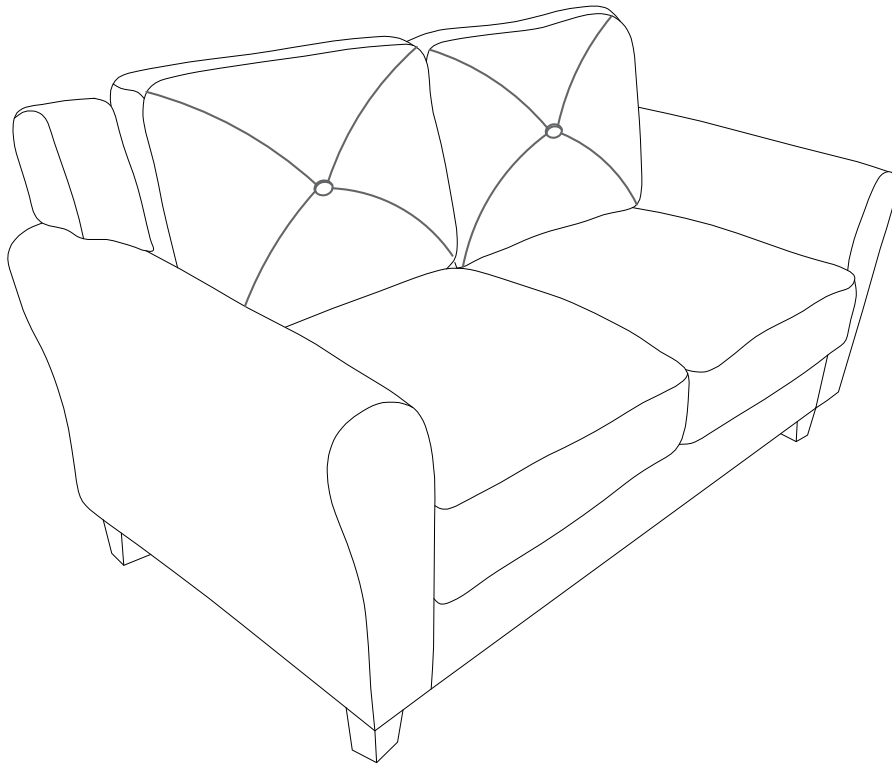

ITEM NO.SFKR1093

NOTE:

This brochure contains IMPORTANT safty info. Please read and keep for future reference.

MAINTAINANCE AND WARNING

- 1.Keep furniture away from heat sources.
- 2.Do not clean furniture with harsh cleaner or polishes.Do not use detergents,solvents,abrasives,spray packs or leather cleaner. Use non-color mild soa with warm water to clean spills(Mix 1:10 soap to water).
- 3.Do not place furniture under direct sunlight,material will possibly fade over time.
- 4.Do not use on site dry cleaning machine.Children should not climb or jump on the furniture.
- 5.Do not write on furniture that is not protectedby a padded barrier.
- 6.Not for commercial use,only for residential use.



Weight Limitation

600 LBS

PARTS LIST

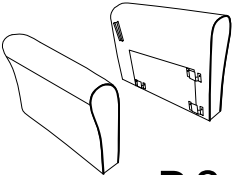
A	x1
 R&L	
Right/Left Facing ARM	

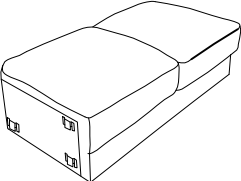
B	x1
	
Sofa Body	

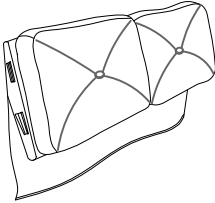
C	x1
	
Back Deck	

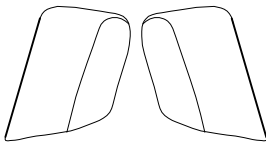
D	x1
 R&L	
Right/Left Backrest Ear Piece	

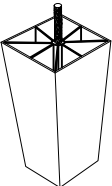
E	x4
	
Legs	

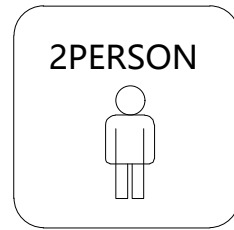

ASSEMBLY INSTRUCTIONS

STEP-1

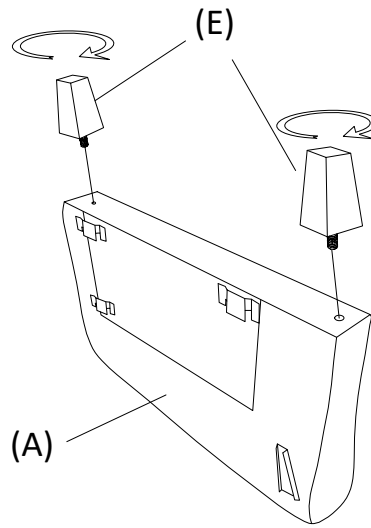
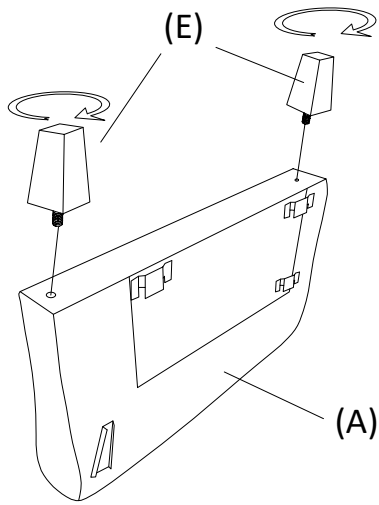

STEP-2

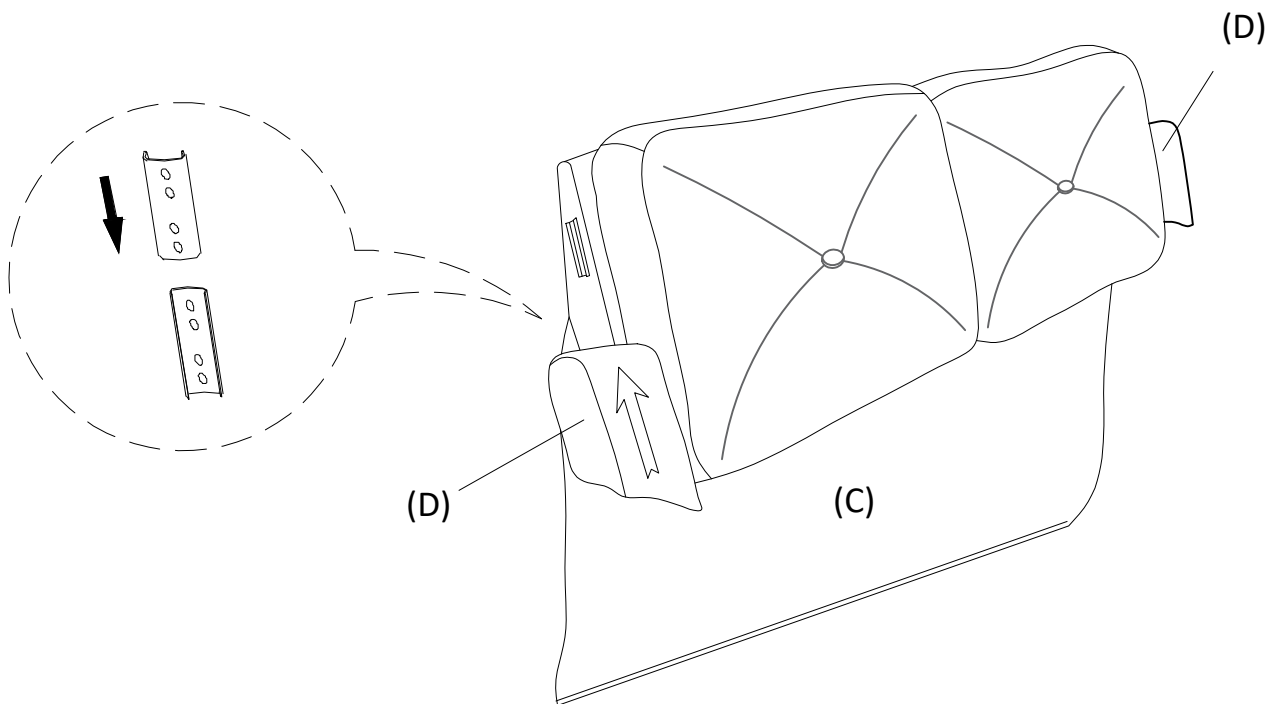

ASSEMBLY INSTRUCTIONS

STEP-3

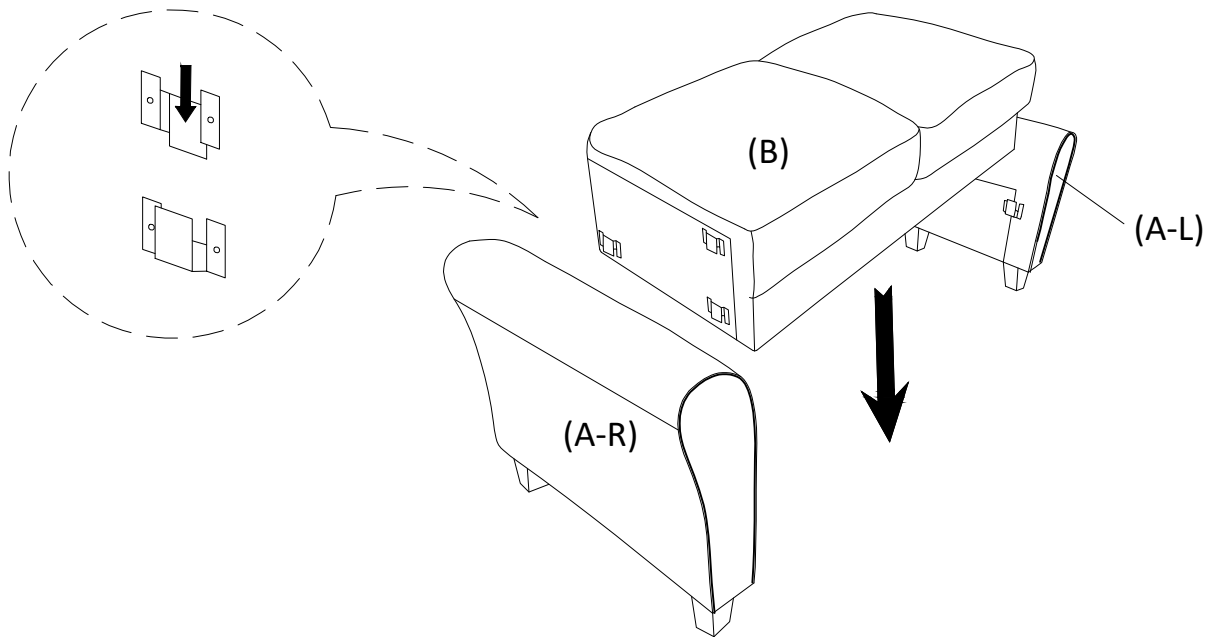

STEP-4

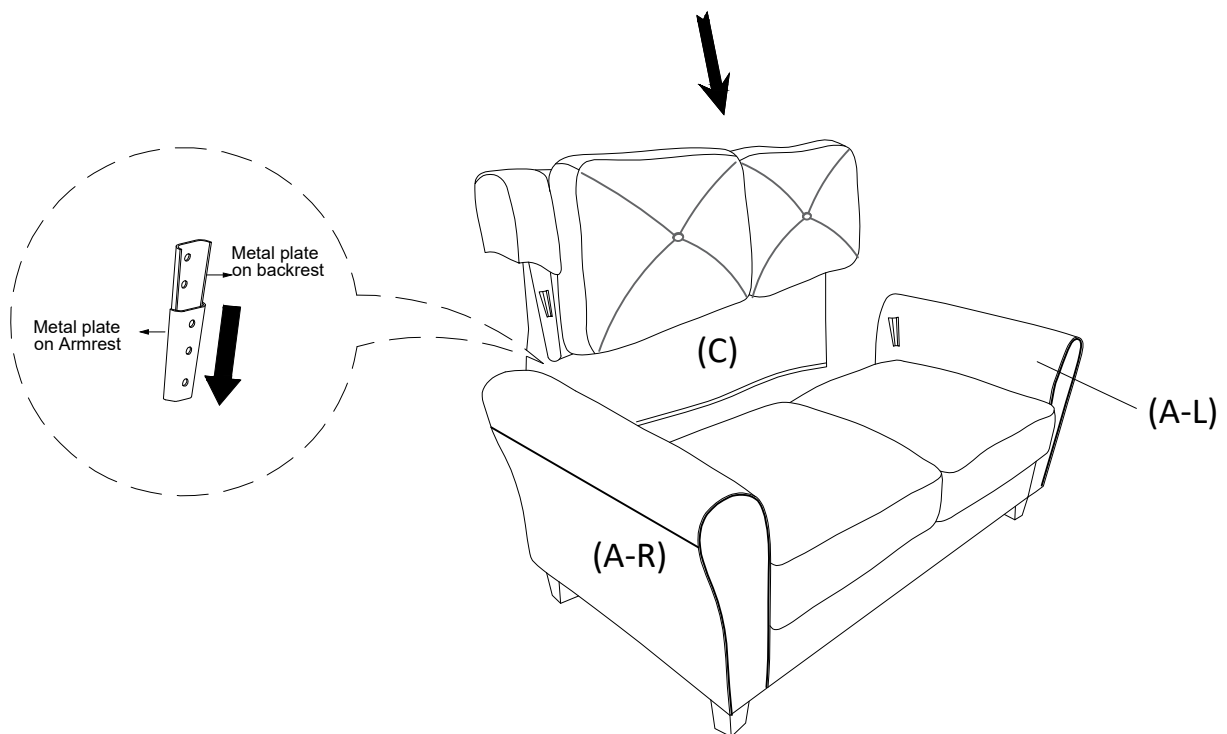

ASSEMBLY INSTRUCTIONS

STEP-5

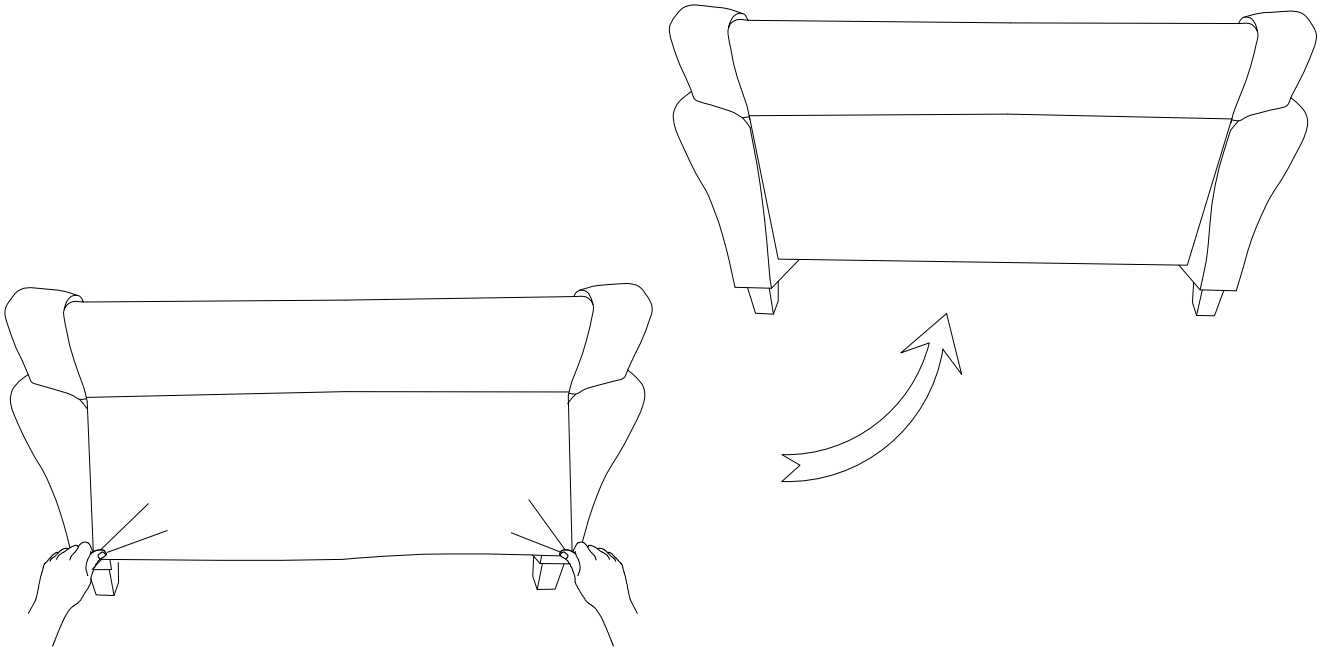

COMPLETED

