

HULALA

H O M E

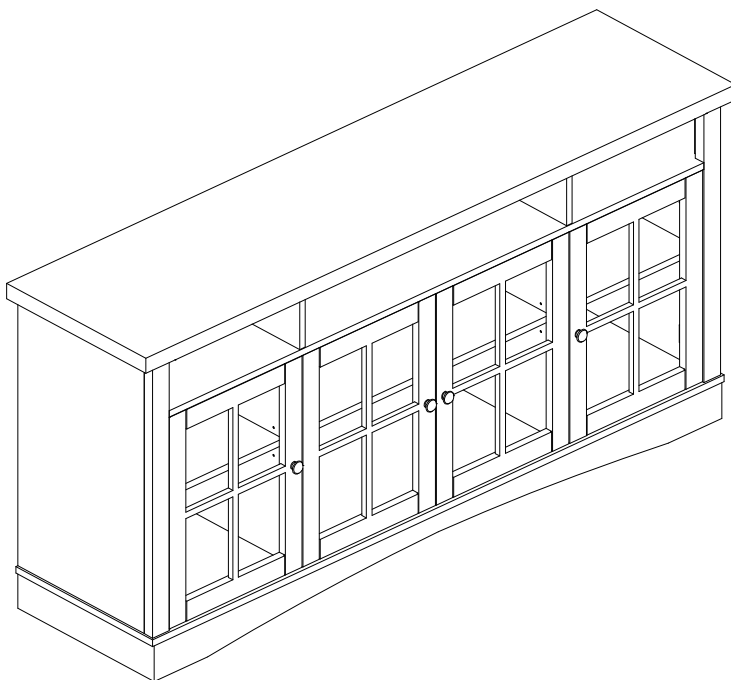

ITEM NO.TVHM0779

NOTE:

This brochure contains IMPORTANT safty info. Please read and keep for future reference.

MAINTAINANCE AND WARNING

- 1.Keep furniture away from heat sources.
- 2.Do not clean furniture with harsh cleaner or polishes.Do not use detergents,solvents,abrasives,spray packs or leather cleaner. Use non-color mild soa with warm water to clean spills(Mix 1:10 soap to water).
- 3.Do not place furniture under direct sunlight,material will possibly fade over time.
- 4.Do not use on site dry cleaning machine.Children should not climb or jump on the furniture.
- 5.Do not write on furniture that is not protectedby a padded barrier.
- 6.Not for commercial use,only for residential use.



Weight Limitation
150 LBS

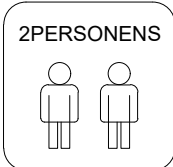
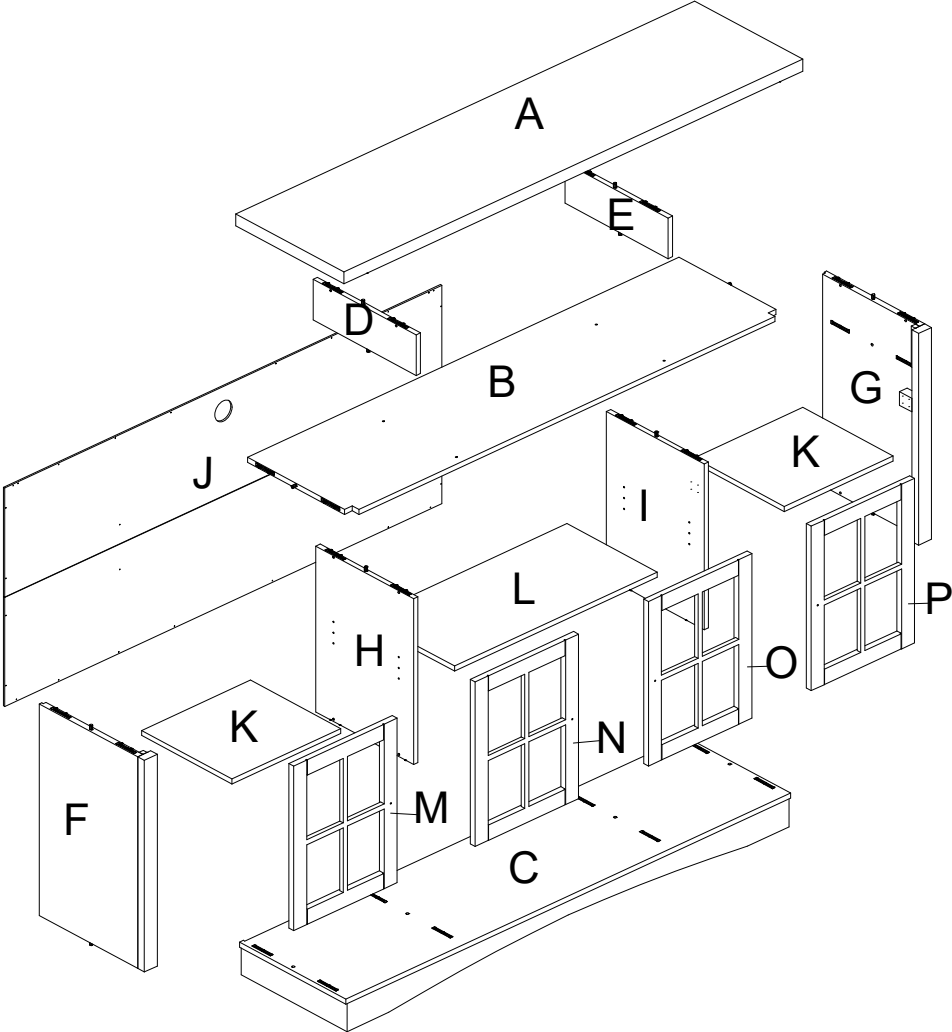

EXPLOSIVE VIEW



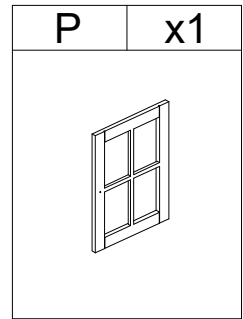
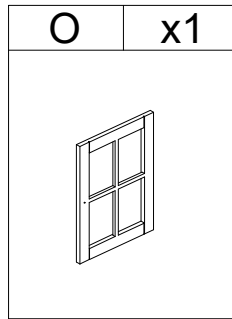
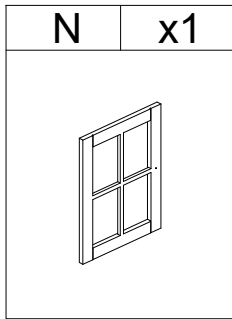
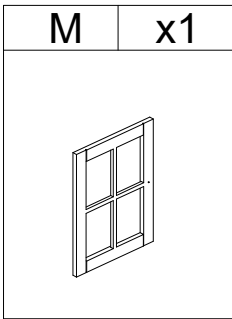
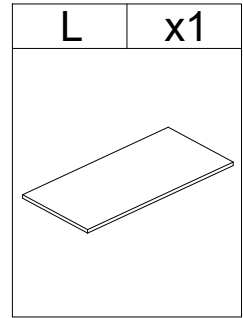
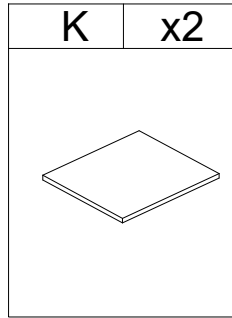
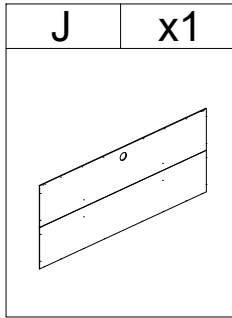
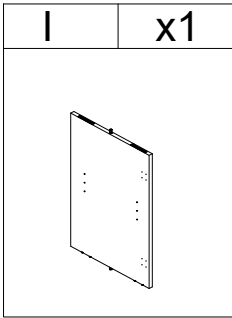
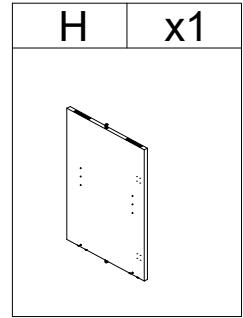
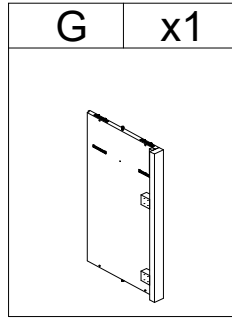
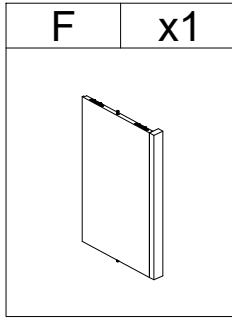
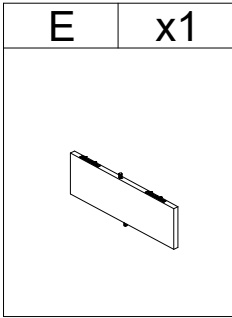
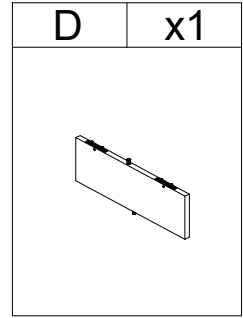
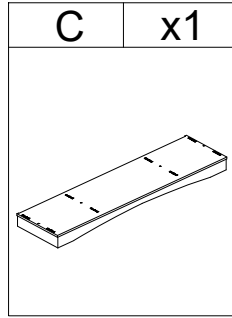
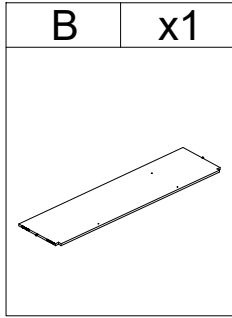
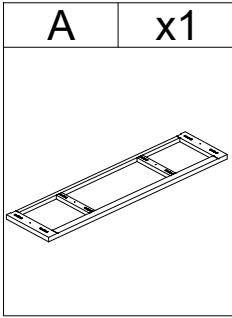

PARTS LIST











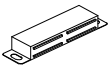
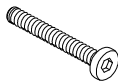

HARDWARE LIST

#1	x52	#2	x30
			
ø3.5*14mm*6#		ø3*14mm*6#	



HARDWARE SPARE LIST

#1	x1	#2	x1
			
ø3.5*14mm*6#		ø3*14mm*6#	

HARDWARE LIST

#3	x1	#4	x4	#5	x12	#6	x4	#7	x4	#8	x4
											
		φ1/4"*1"						φ5/32"*1"			
#9	x4	#10	x4	#11	x4	#12	x4	#13	x2	#14	x1
											
				φ3.5*35mm*7#							

TOOL LIST

#15	x1	#16	x1
			
M4			

ASSEMBLY INSTRUCTIONS

STEP-1

1. Use screw #2 to attach magnetic catch #3 to the corresponding hole of fixed shelf panel (B), tighten screw with screwdriver #16.

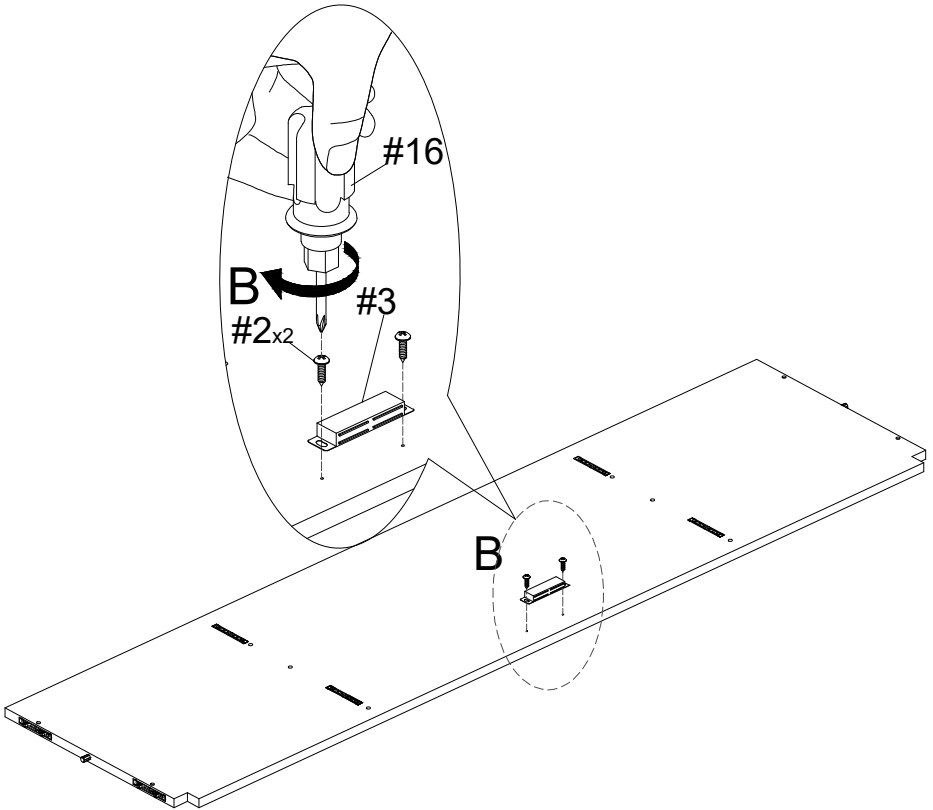

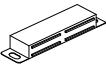
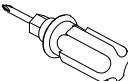

#2	x2	#3	x1	#16	x1
					
ø3*14mm*6#					

ASSEMBLY INSTRUCTIONS

STEP-2

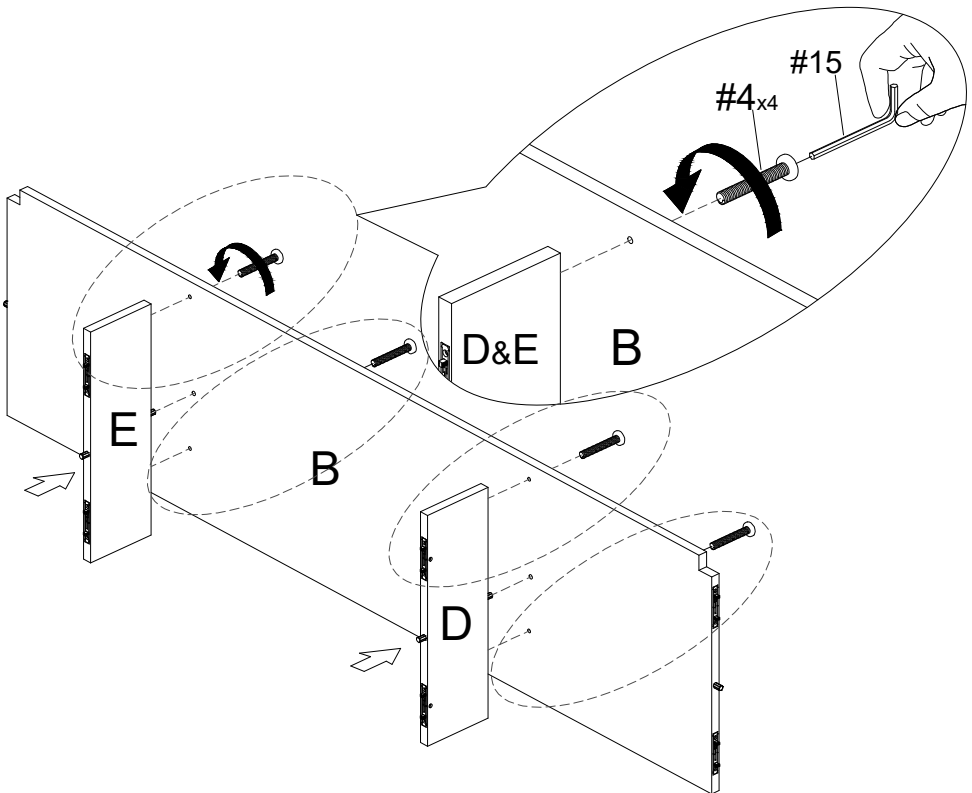
1. Use bolt #4 to attach part (D&E) to part (B), make sure all holes aligned and tighten bolt #4 with allen key #15.

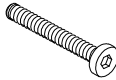



#4	x4	#15	x1
			
Ø1/4"×1"		M4	

ASSEMBLY INSTRUCTIONS

STEP-3

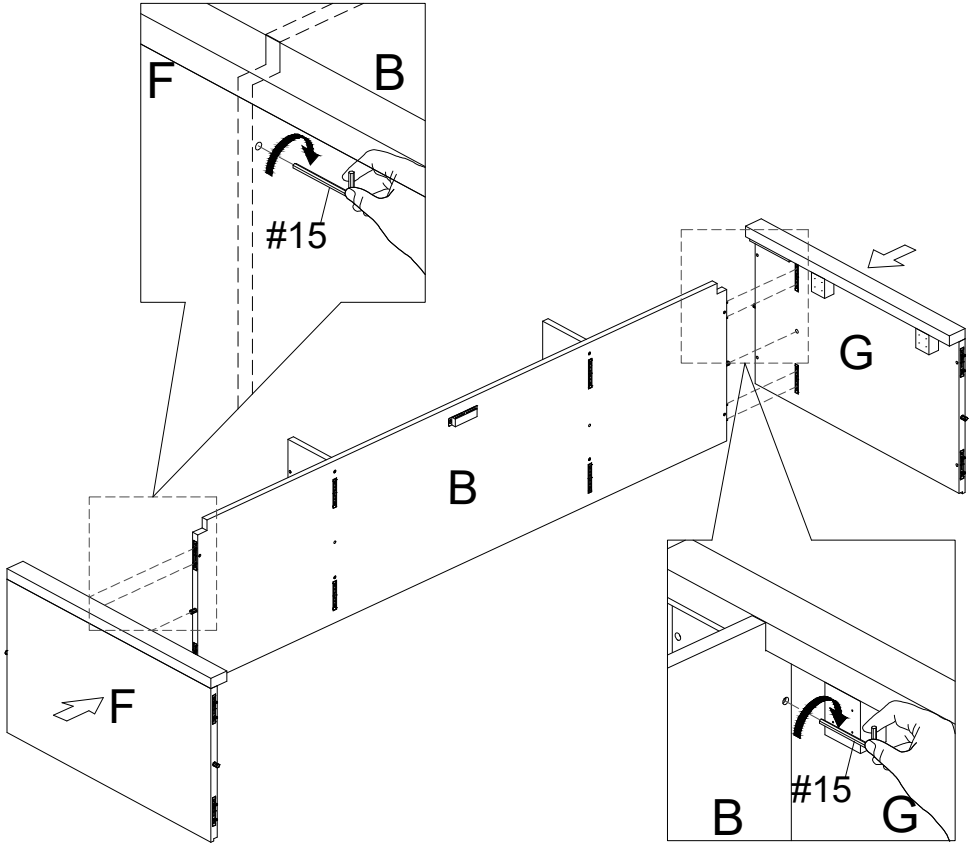
1. Insert side panel (F&G) into panel (B), make sure all holes aligned and use allen key #15 to tighten it as picture show.





#15	x1
	
M4	

ASSEMBLY INSTRUCTIONS

STEP-4

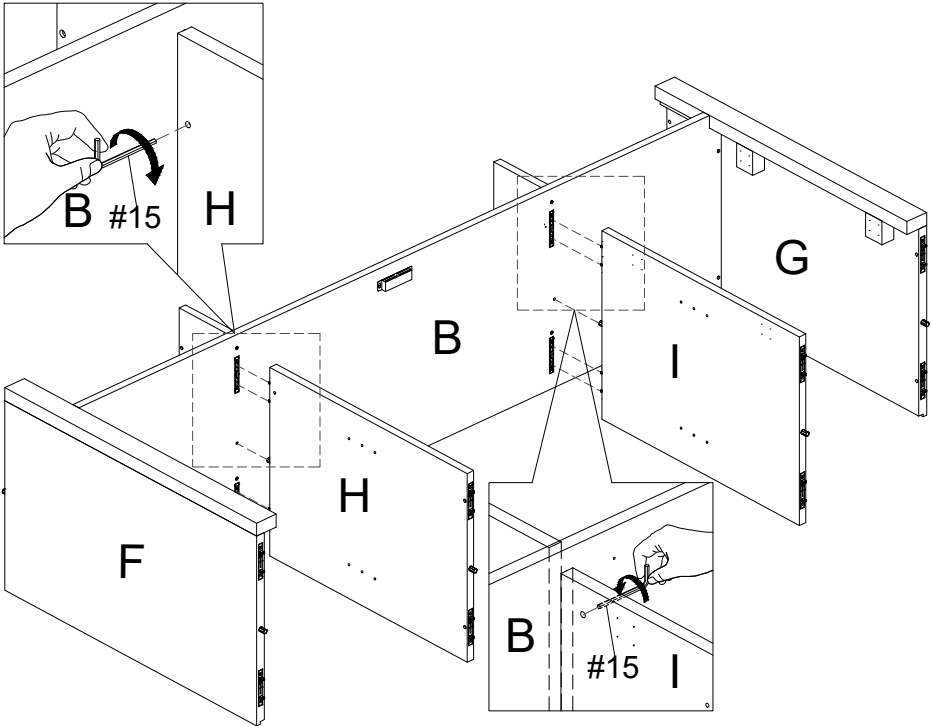
1. Insert the intermediate bulkheads (H&I) into the panel (B), making sure all holes line up and tighten with an Allen key #15 as shown.





#15	x1
	
M4	

ASSEMBLY INSTRUCTIONS

STEP-5

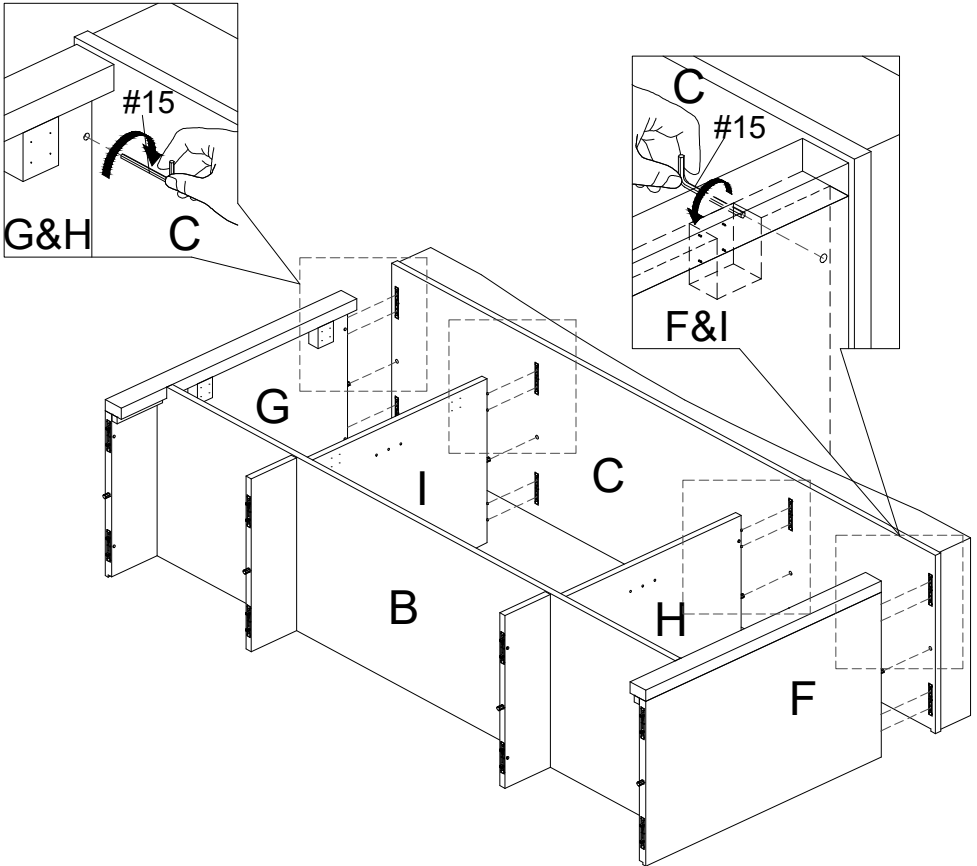
1. Insert the bottom panel C into the (F&G&H&I), making sure all holes line up and tighten with an Allen key #15 as shown.





#15	x1
	
M4	

ASSEMBLY INSTRUCTIONS

STEP-6

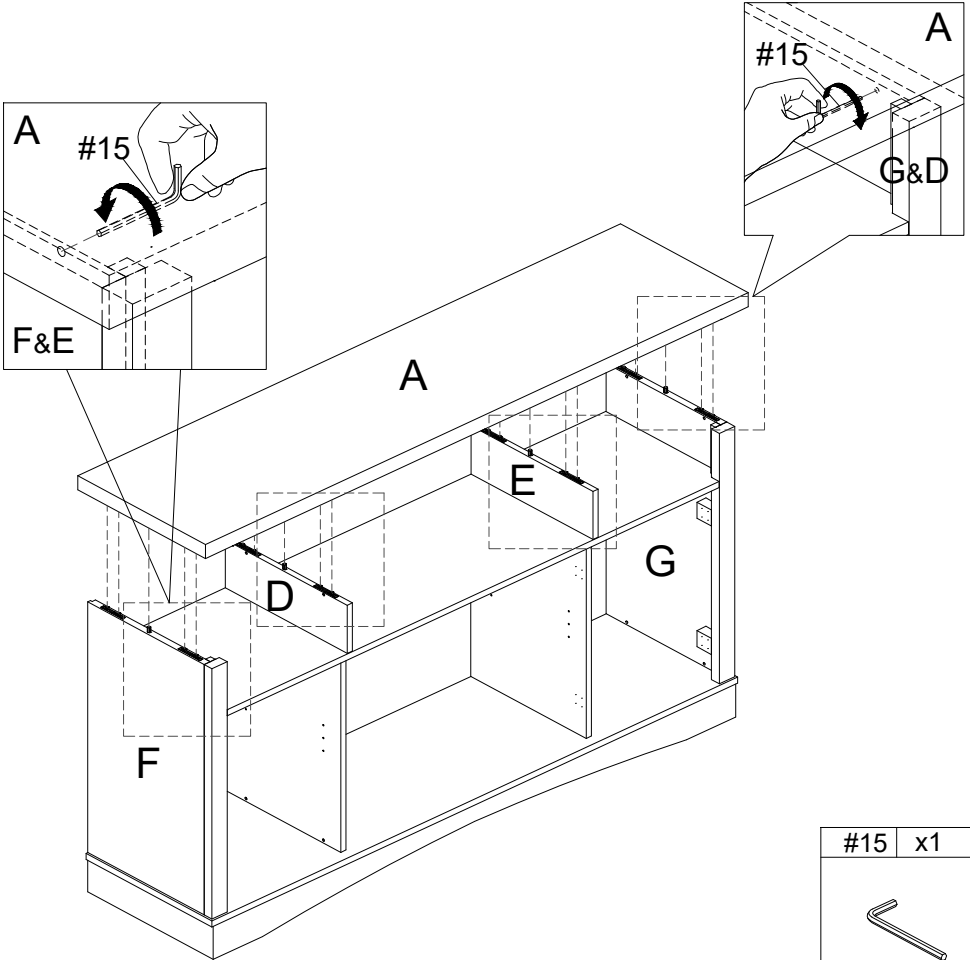
1. Insert the panel A into the (F&D&E&G), making sure all holes line up and tighten with an Allen key #15 as shown.



#15	x1
	
M4	

ASSEMBLY INSTRUCTIONS

STEP-7

1. Open the back panel (J), Mount part #14 to back plane J, insert back panel (J) into the groove of preassembled step 6, make sure all holes aligned and use screw #2 to attach them , tighten screw #2 with screwdriver #16.

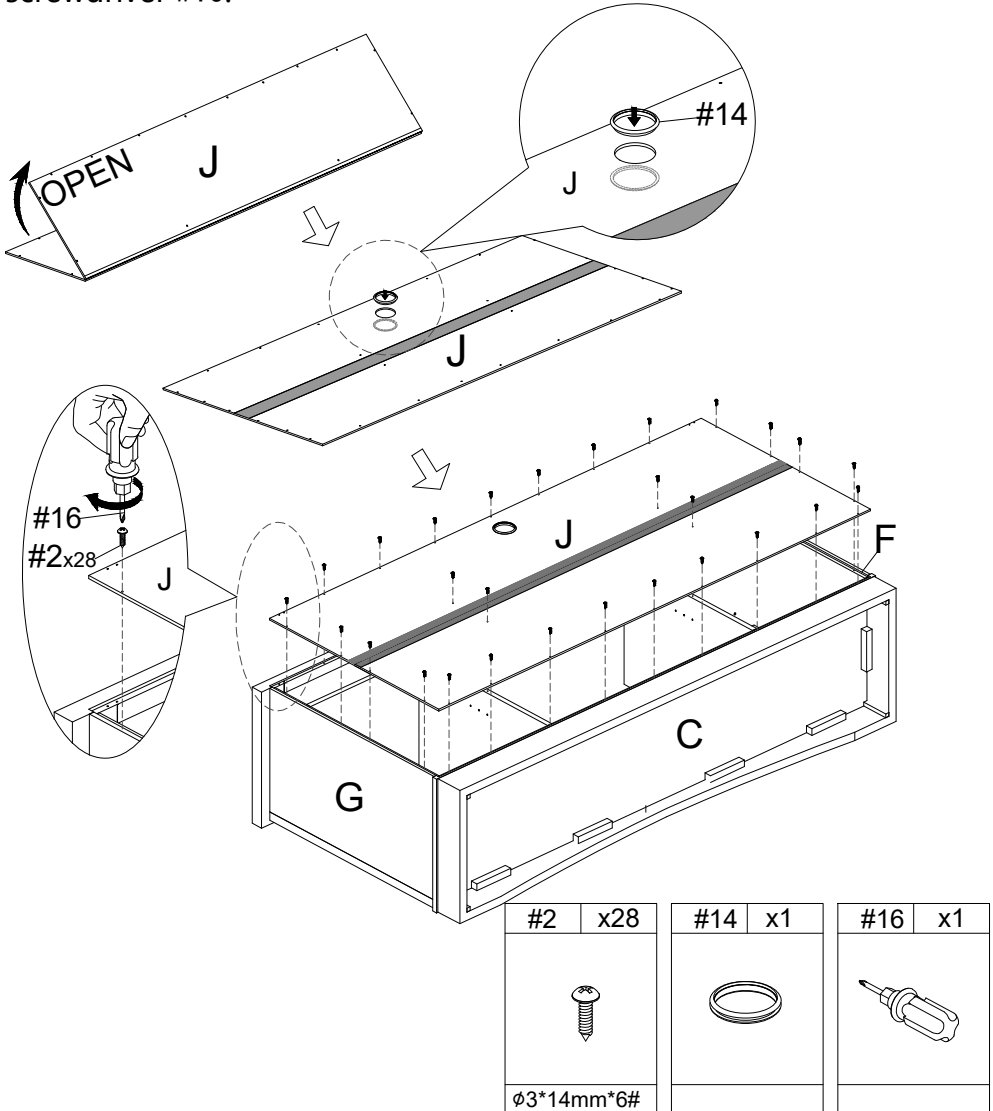

ASSEMBLY INSTRUCTIONS

STEP-8

1. Insert shelf pin #5 into pre-assembled unit at step 7.
2. attach adjustable shelf (K&L) to pin #5.

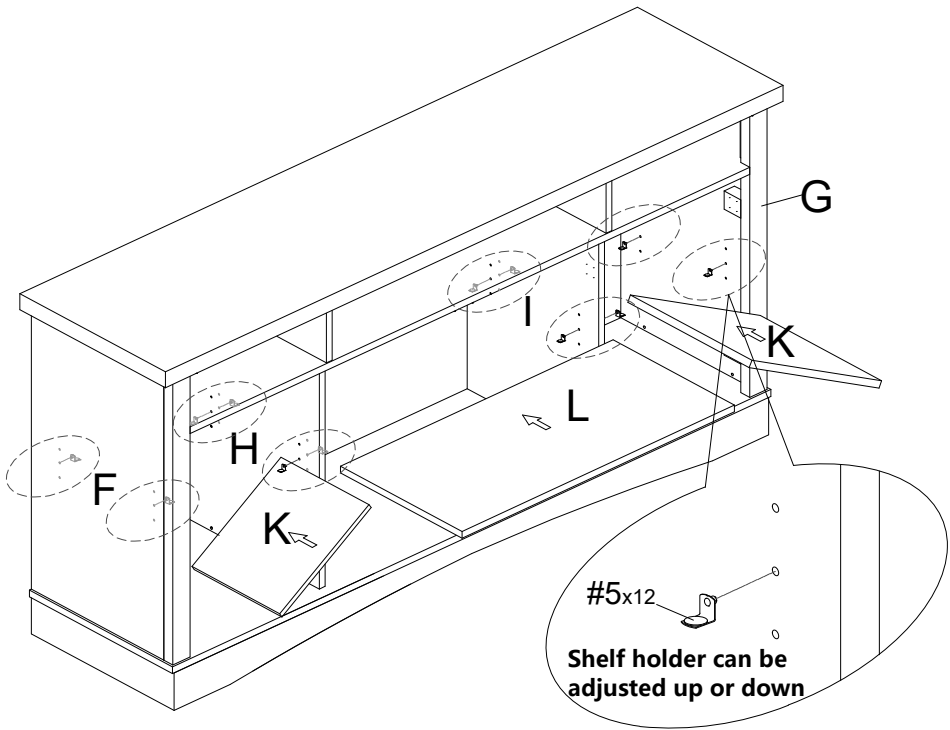



#5	x12
	

ASSEMBLY INSTRUCTIONS

STEP-9

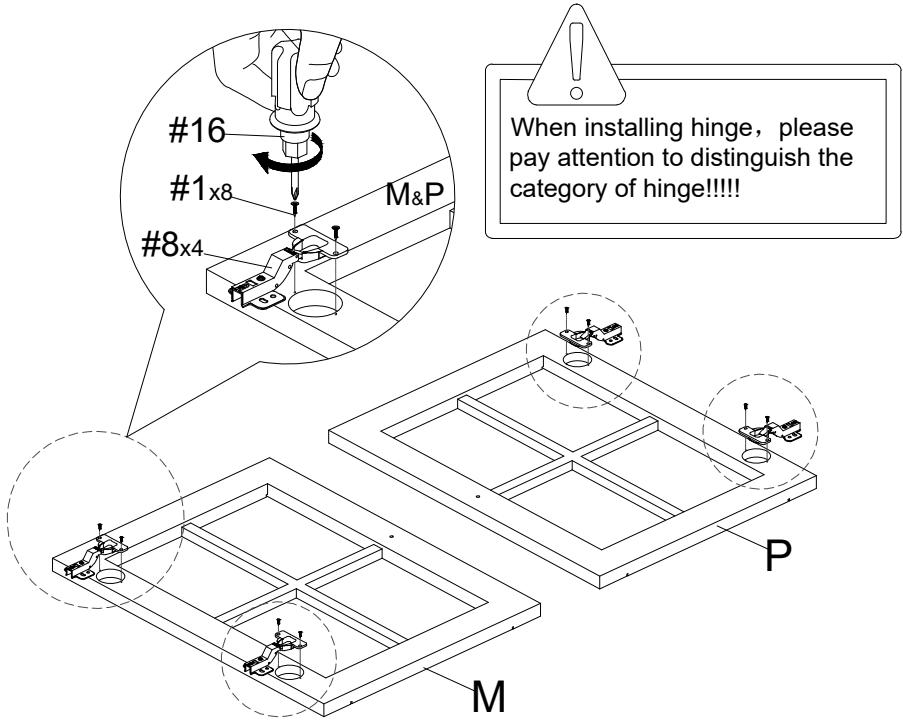
1. Use screw #1 to attach the hinges #8 to door panel (M)&(P), tighten screws with screwdriver #16.



#1	x8
	
Ø3.5*14mm*6#	

#8	x4
	

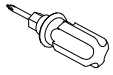

#16	x1
	

ASSEMBLY INSTRUCTIONS

STEP-10

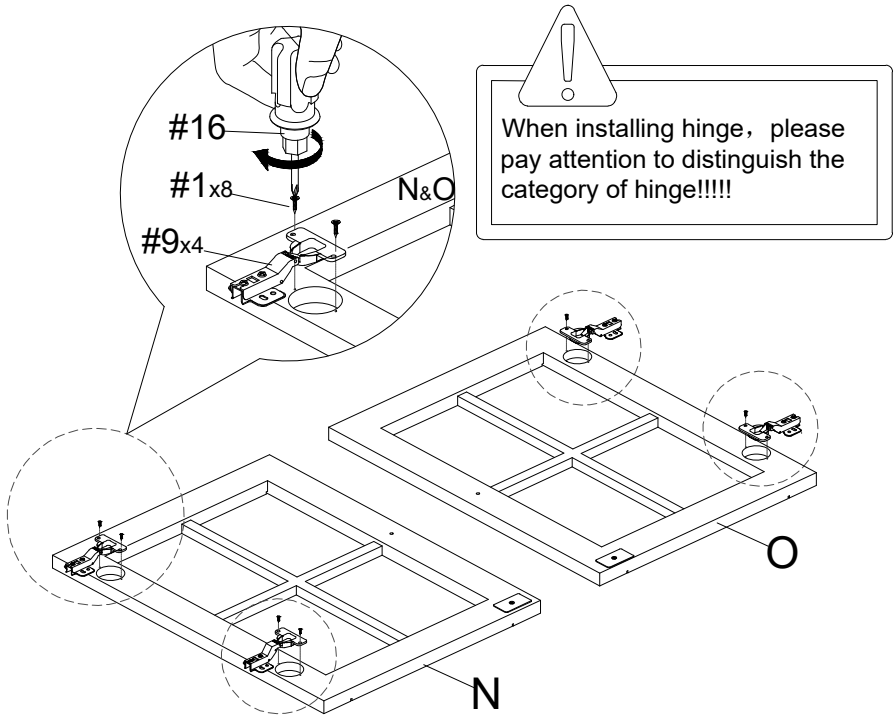
1. Use screw #1 to attach the hinges #9 to door panel (N)&(O), tighten screws with screwdriver #16.



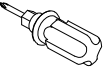

#1	x8	#9	x4	#16	x1
					
Ø3.5*14mm*6#					

ASSEMBLY INSTRUCTIONS

STEP-11

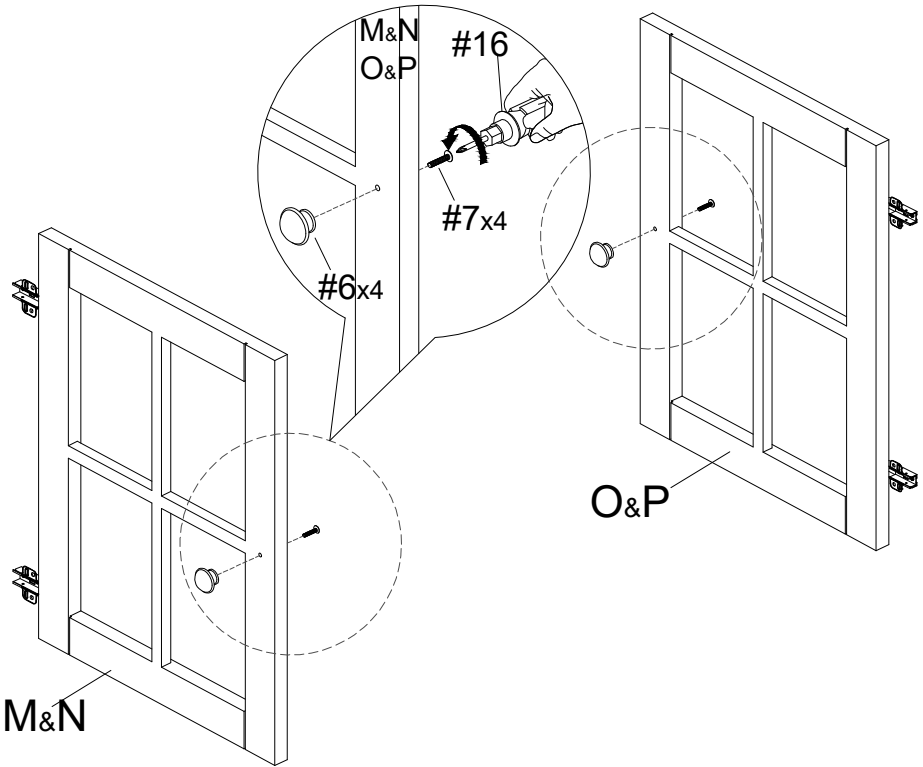
Use bolt #7 to attach handle #6 to door panel (M)&(N)&(O)&(P), tighten bolts with screwdriver #16

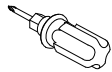

#6	x4	#7	x4	#16	x1
					
		ø5/32"*1"			

ASSEMBLY INSTRUCTIONS

STEP-12

1. Use screw #1 to attach door (M&P) to pre-assemble unit at step 8, tighten screw #1 with screwdriver #16.

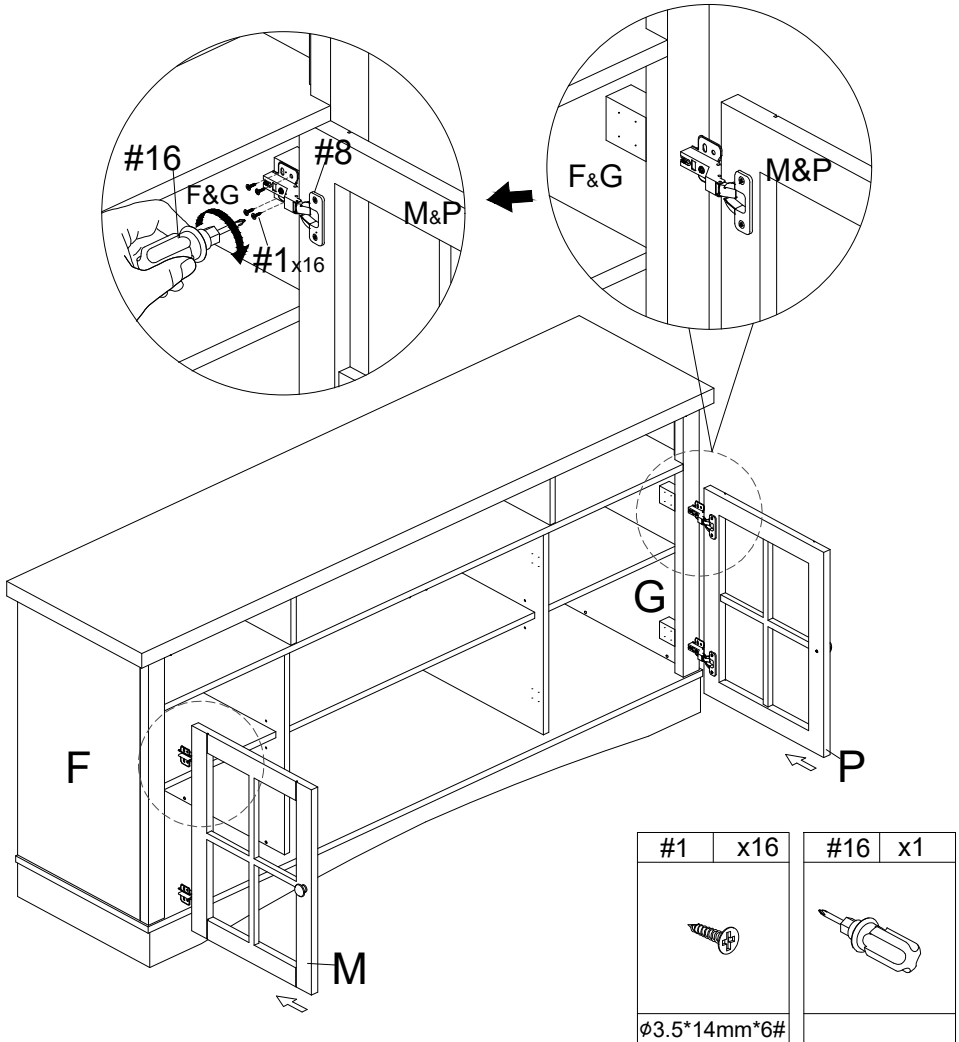

ASSEMBLY INSTRUCTIONS

STEP-13

1. Use screw #1 to attach door (N&O) to pre-assemble unit at step 12 ,tighten screw #1 with screwdriver #16 .

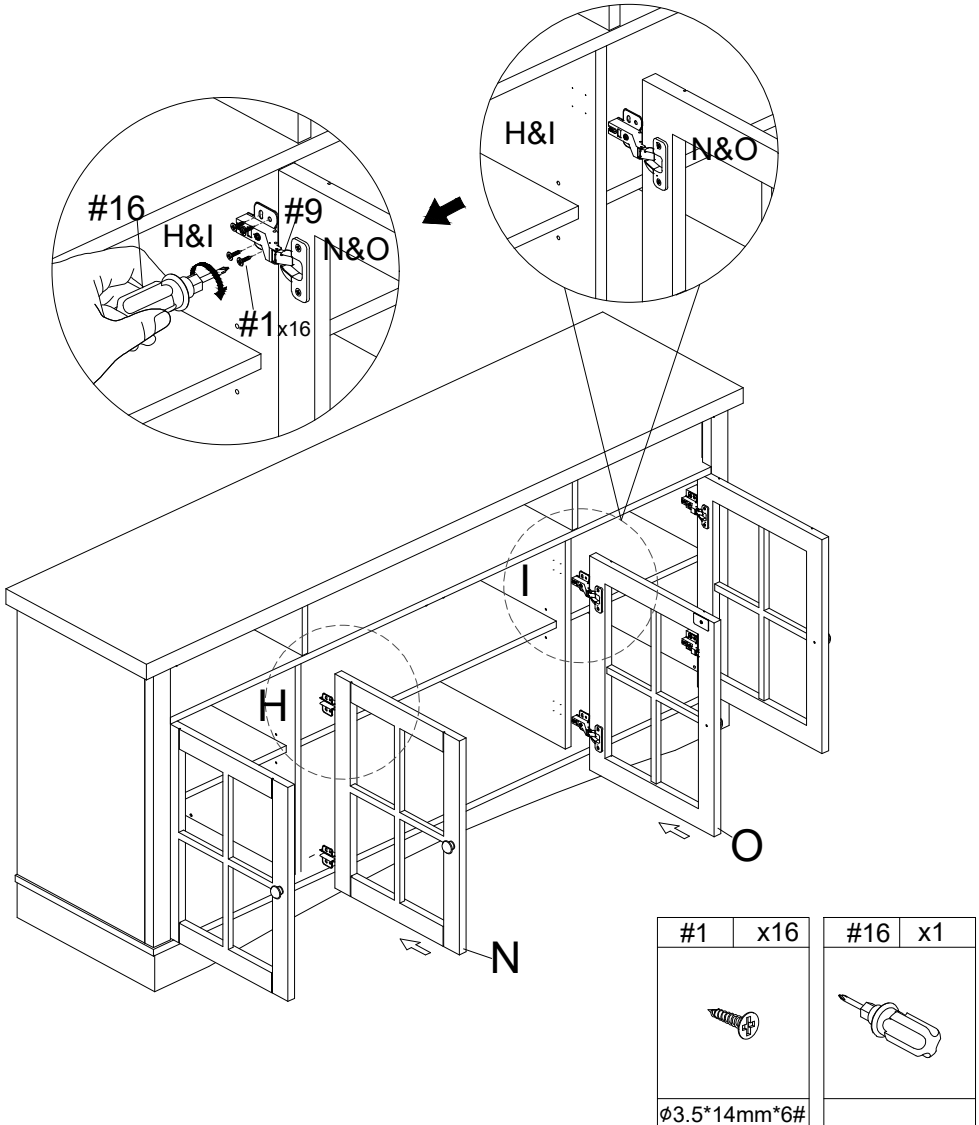

ASSEMBLY INSTRUCTIONS

STEP-14

Concealed hinges are three-way adjustable:

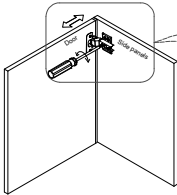

Horizontal
by screw adjustment!

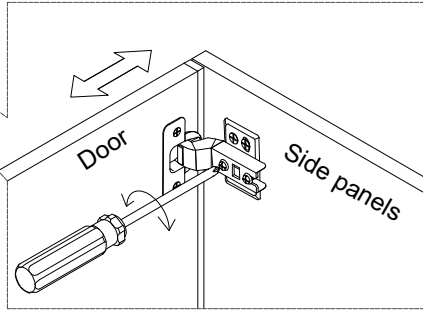

Concealed hinges are three-way adjustable:

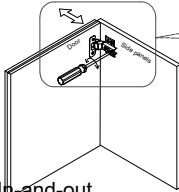

In-and-out
by loosening the hinge arm
mounting screw or via cam
adjustment!

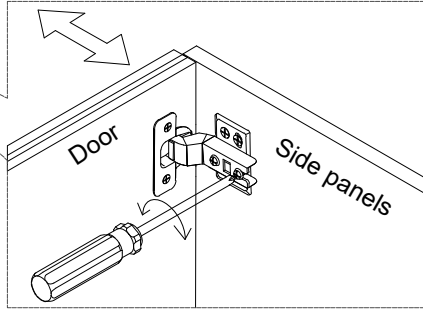

Concealed hinges are three-way adjustable:

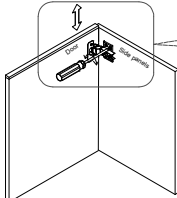

Vertical via slots in
the mounting plate
or via cam adjustment!

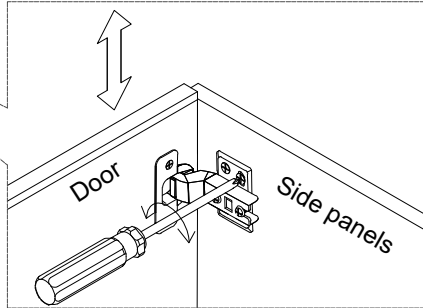

Video for door adjustment

Hinge adjustment method

ASSEMBLY INSTRUCTIONS

STEP-15

1. Attach part #10 to parts (J) with screw #1 and tighten the screw with screwdriver #16.

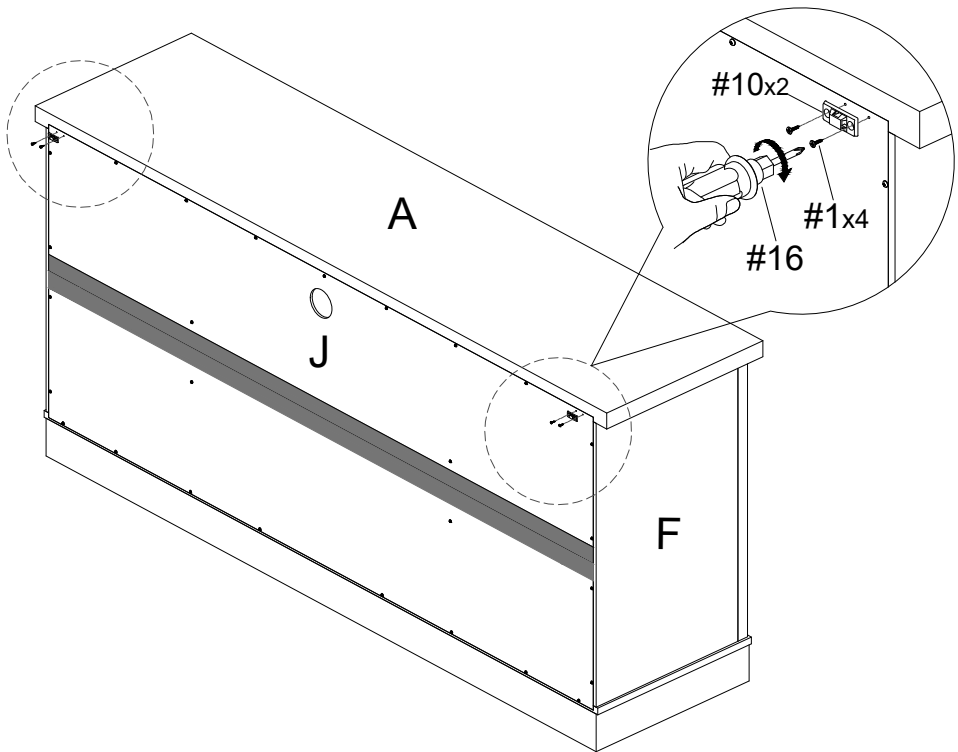

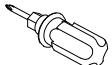

#1	x4
	
Ø3.5*14mm*6#	

#10	x2
	

#16	x1
	

ASSEMBLY INSTRUCTIONS

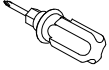
#10	x2	#11	x4	#12	x4	#16	x1
							
		ø3.5*35mm*7#					

STEP-16

1. Mark the position on the wall, that corresponds to the location of bracket #10 on the back panel J; Drill and insert the expandable screw #12 by hammer.
2. Assemble the bracket #10 to the wall. Align the hole in the bracket #10 with the expandable screw #12, use screw #11 to attach it, tighten screw #11 with screwdriver #16.

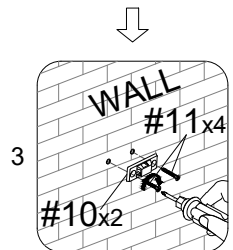
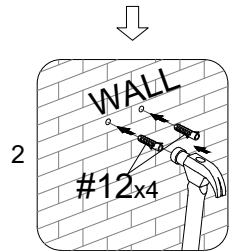
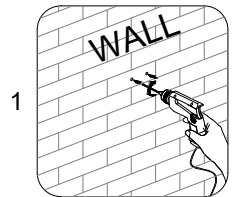
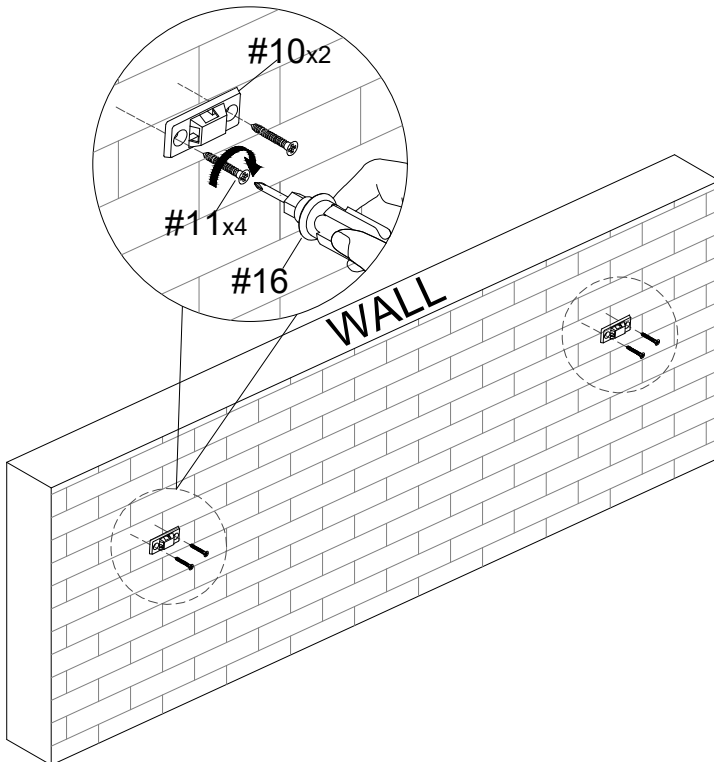

ASSEMBLY INSTRUCTIONS

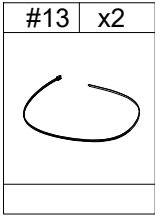

STEP-17

1. Let the plastic belt #13 pass through the both part #10 and pull tightly.

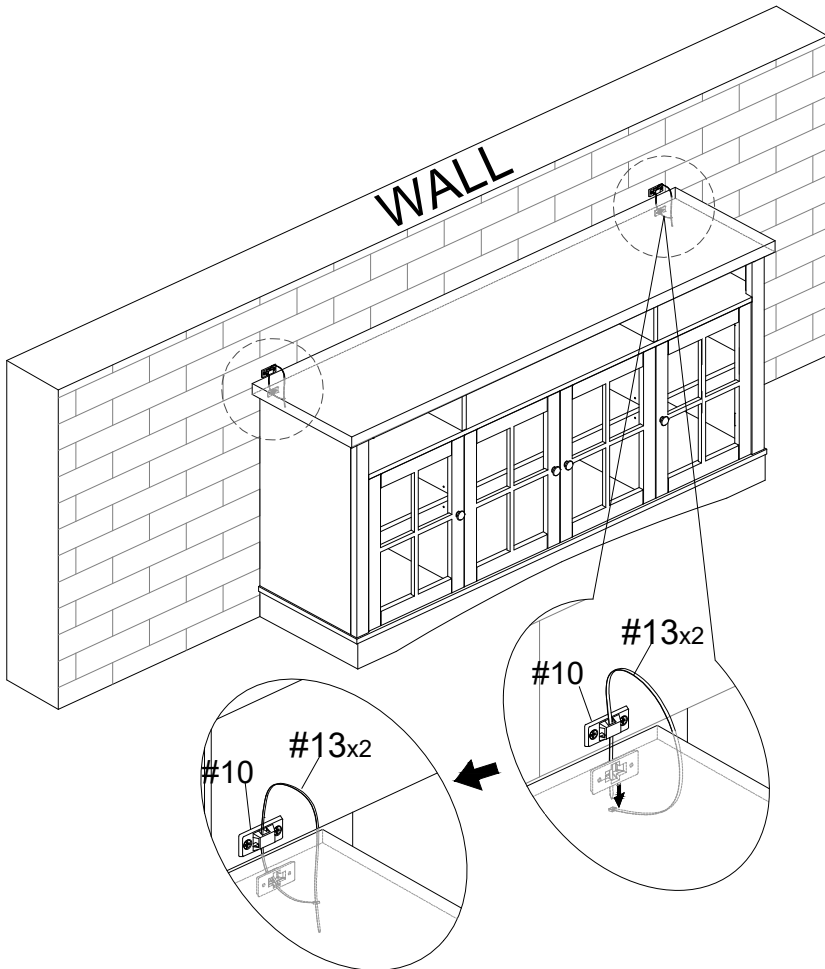

WARRANTY

1. We strive to offer high-quality products, and we also try our best to satisfy each and every customer that orders from us with product or service as needed.
2. We provide 30 days warranty starting from the time you receive the item. Each customer must provide a record of their order such as the order number, or item receipt for any items that are out of the warranty period you may also still receive.
3. Replacement parts by purchasing them with our company if they are available.

Are you having difficulty
With assembly? Missing parts?
Please send email with your order No to
customerservice@hulalahome.com
For return, please check the return policy with
the retailer or market place you bought from.

Appreciate your purchasing from us.
Pop up your life by our furniture piece!