

HULALA

H O M E

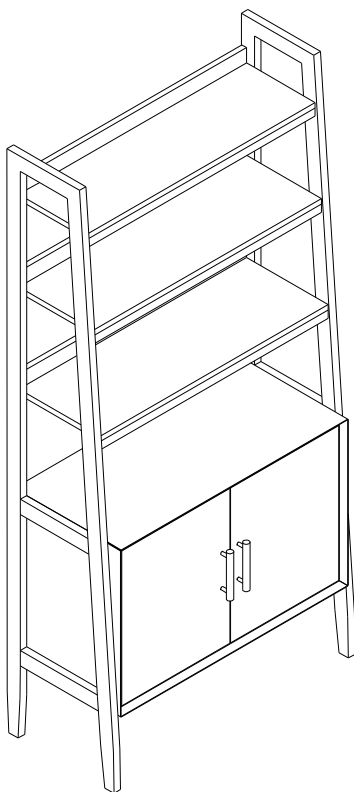

ITEM NO.BCYJ0741

NOTE:

This brochure contains IMPORTANT safty info. Please read and keep for future reference.

MAINTAINANCE AND WARNING

- 1.Keep furniture away from heat sources.
- 2.Do not clean furniture with harsh cleaner or polishes.Do not use detergents,solvents,abrasives,spray packs or leather cleaner. Use non-color mild soa with warm water to clean spills(Mix 1:10 soap to water).
- 3.Do not place furniture under direct sunlight,material will possibly fade over time.
- 4.Do not use on site dry cleaning machine.Children should not climb or jump on the furniture.
- 5.Do not write on furniture that is not protectedby a padded barrier.
- 6.Not for commercial use,only for residential use.



Weight Limitation
100 LBS

EXPLOSIVE VIEW

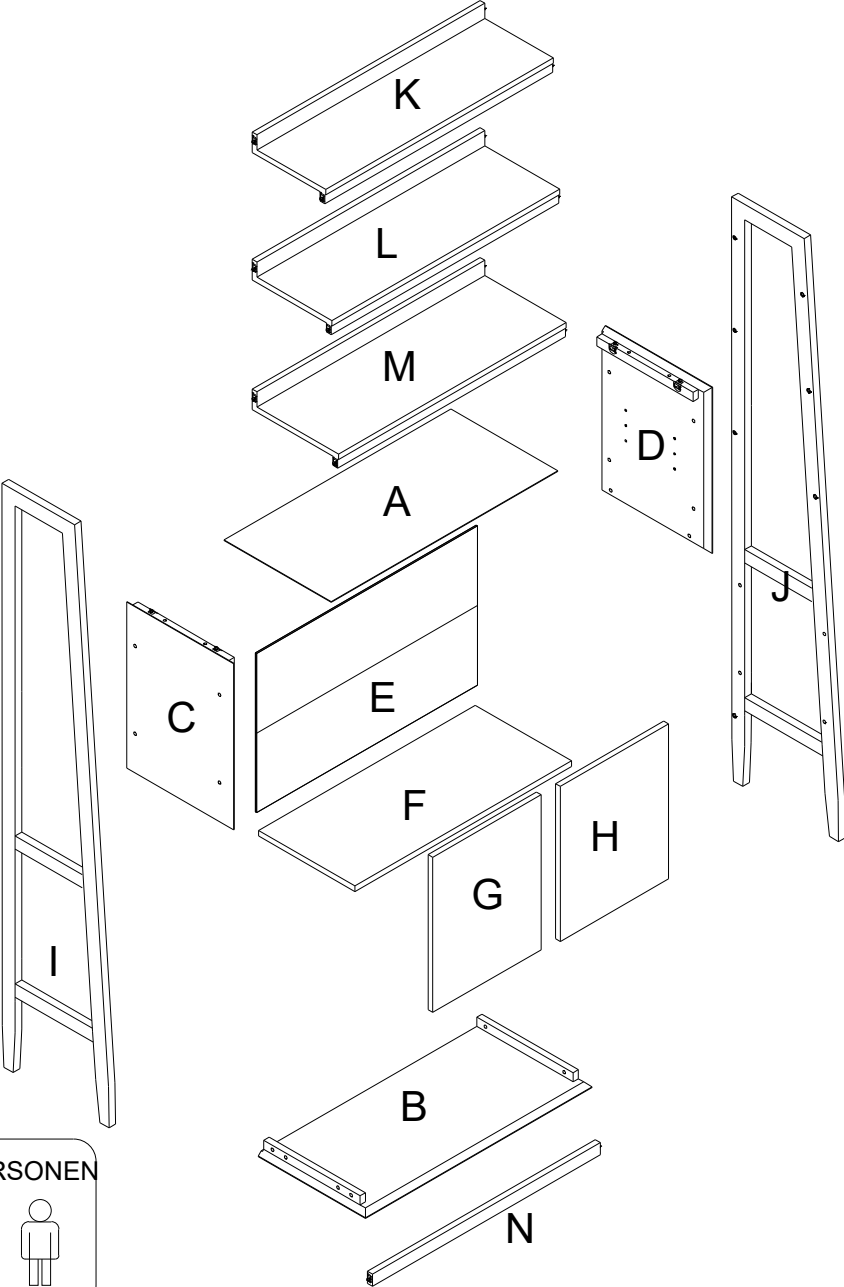







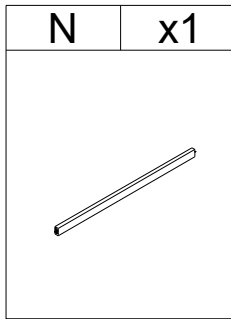
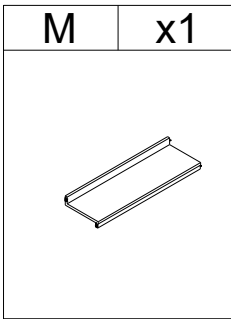
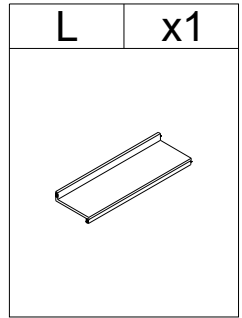
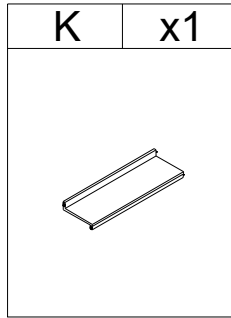
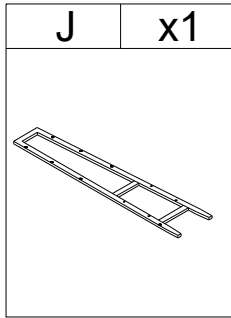
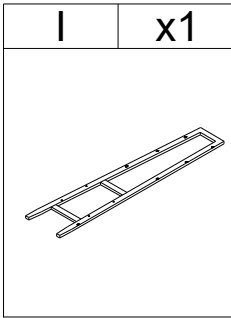
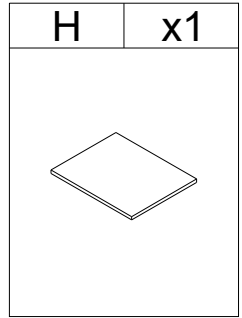
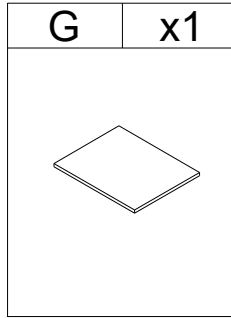
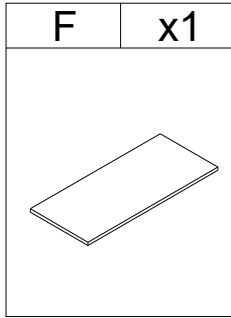
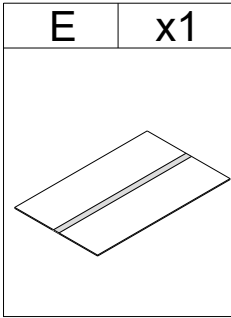
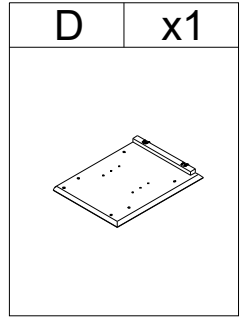
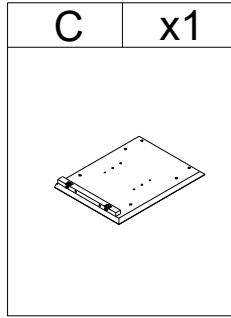
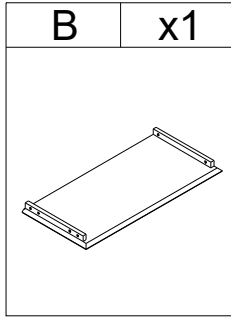
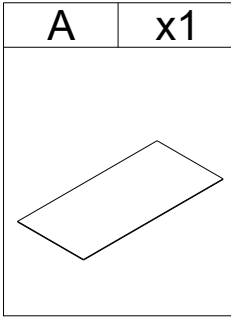



2 PERSONEN

An icon consisting of two simple human figures standing side-by-side, enclosed in a rounded rectangular border.



PARTS LIST

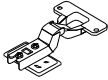







HARDWARE LIST

| | | | | | | | | | | | |
|---|-----|---|-----|---|----|---|----|---|-----|---|-----|
| #1 | x26 | #2 | x14 | #3 | x4 | #4 | x4 | #5 | x16 | #6 | x12 |
|  | |  | |  | |  | |  | |  | |
| Ø3*12mm | | Ø8*30mm | | Ø6*30mm | | Ø5/32"*3/4" | | Ø3*12mm | | Ø1/4"*1" | |
| #7 | x2 | #8 | x4 | #9 | x1 | #12 | x4 | #13 | x1 | | |
|  | |  | |  | |  | |  | | | |
| | | | | | | | | Safety Strap Kit | | | |

TOOL LIST

| | | | |
|---|----|--|----|
| #10 | x1 | #11 | x1 |
|  | |  | |
| M4 | | M5 | |

HARDWARE SPARE LIST

| | | | | | | | | | | | |
|---|----|---|----|---|----|---|----|---|----|---|----|
| #1 | x1 | #2 | x1 | #3 | x1 | #4 | x1 | #5 | x1 | #6 | x1 |
|  | |  | |  | |  | |  | |  | |
| Ø3*12mm | | Ø8*30mm | | Ø6*30mm | | Ø5/32"*3/4" | | Ø3*12mm | | Ø1/4"*1" | |

ASSEMBLY INSTRUCTIONS

STEP-1

1. Use screw #6 respectively to attach part (C),(D) to panel (B),tighten it with allen key #10.

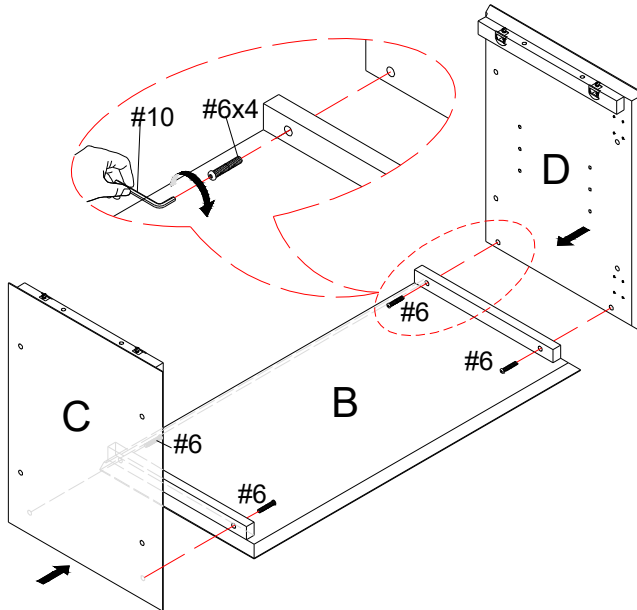

| | |
|---|----|
| #10 | x1 |
|  | |
| M4 | |



| | |
|---|----|
| #6 | x4 |
|  | |
| Ø1/4"*1" | |

ASSEMBLY INSTRUCTIONS

STEP-2

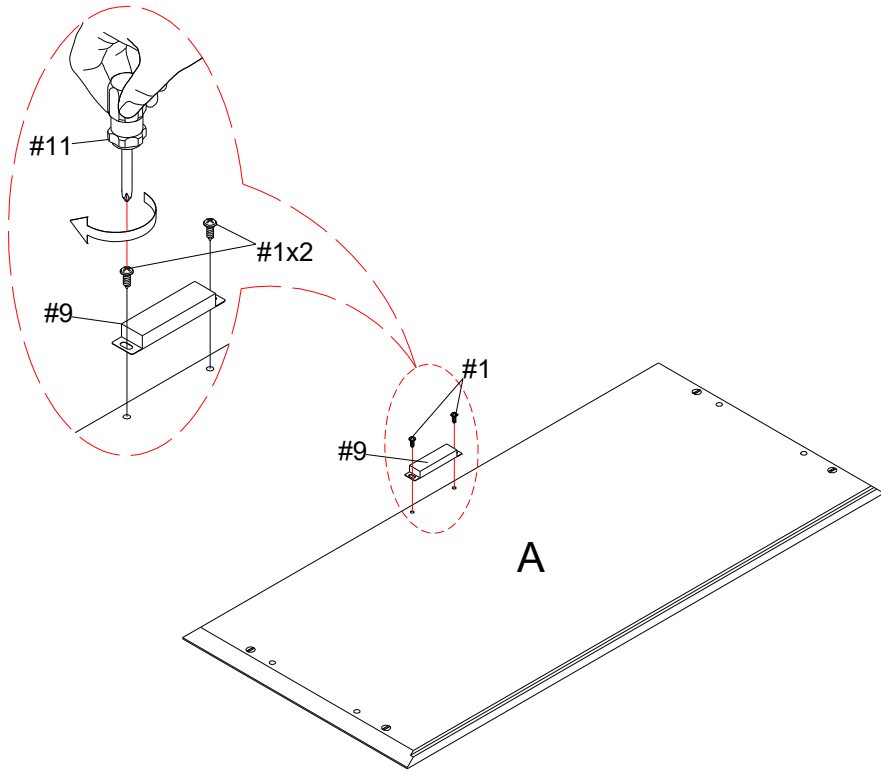
1. Use screw #1 to attach part #9 to panel (A), tighten it with screwdriver #11.



| | | | | | |
|---|----|---|----|--|----|
| #1 | x2 | #11 | x1 | #9 | x1 |
|  | |  | |  | |
| Ø3x12mm | | M5 | | | |

ASSEMBLY INSTRUCTIONS

STEP-3

1. Prepare the parts completed in the first step.

Attach top plate A to assembled units C, D using wooden pin #3 and lock the hardware.

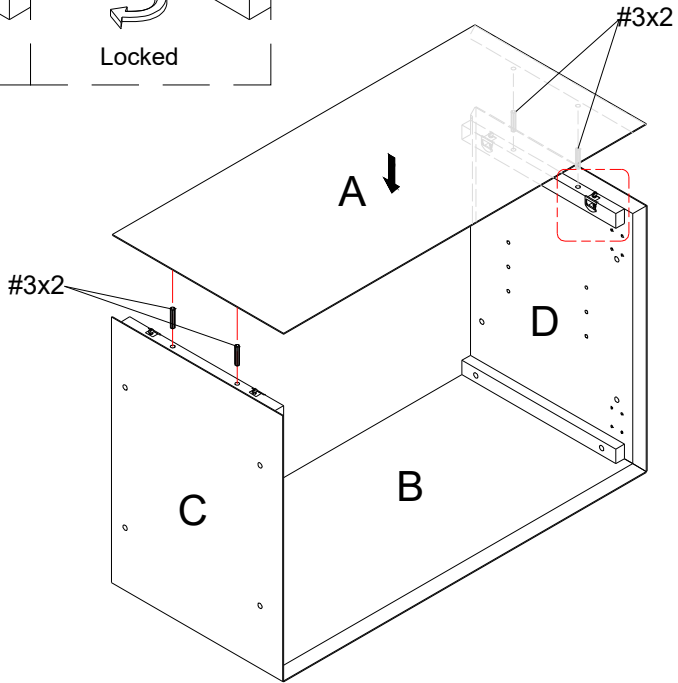
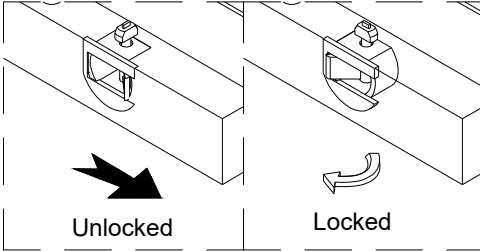

| | |
|--|----|
| #3 | x4 |
|  | |
| Ø6*30mm | |

ASSEMBLY INSTRUCTIONS

STEP-4

1. Open the back panel E.

2. Attach back panel (E) to pre assembled unit at step 3 with screw #5, and tighten it with screwdriver #11.

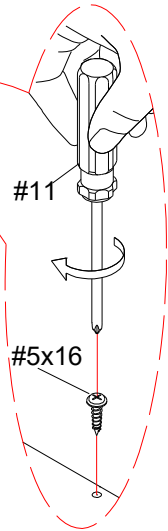
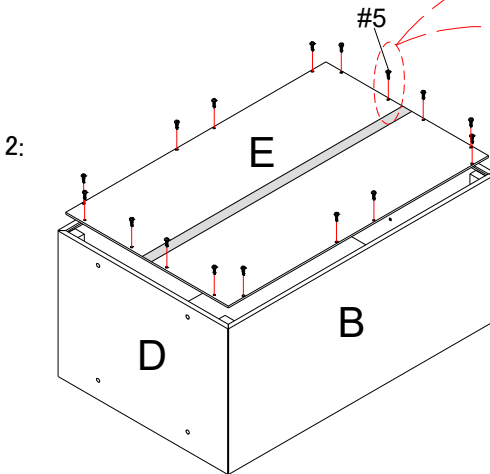
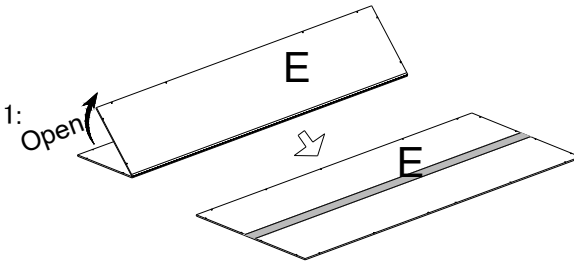

| | |
|---|----|
| #11 | x1 |
|  | |
| M5 | |

| | |
|--|-----|
| #5 | x16 |
|  | |
| Ø3*12mm | |

ASSEMBLY INSTRUCTIONS

STEP-5

1. Attach the right leg (J) to the pre-assembled unit in step 4 with a #6 screw and tighten with a #10 allen key.

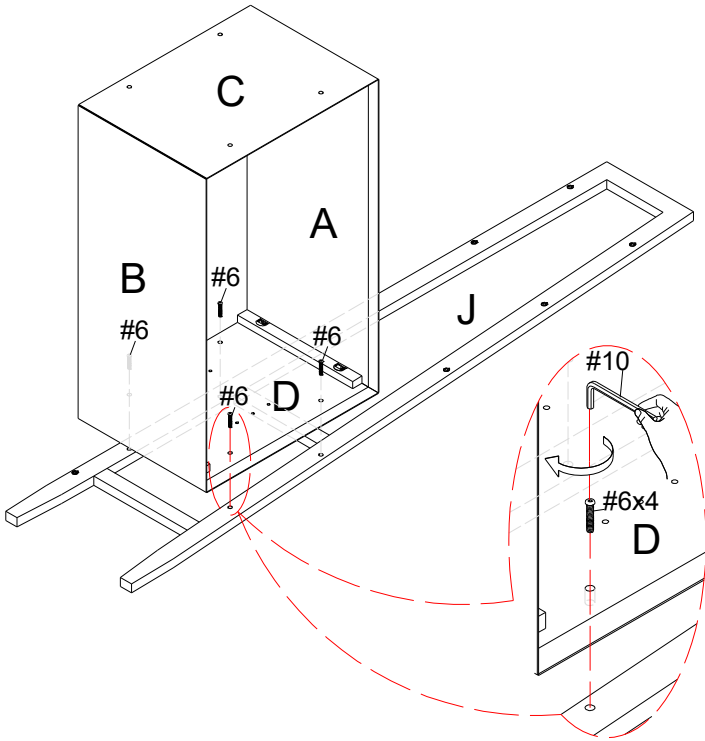

| | |
|---|----|
| #10 | x1 |
|  | |
| M4 | |

| | |
|---|----|
| #6 | x4 |
|  | |
| Ø1/4x1" | |

ASSEMBLY INSTRUCTIONS

STEP-6

1. Attach the shelf (K, L, M, N) to the pre-assembled unit in step 5 with a #2 wooden pin and lock the hardware.

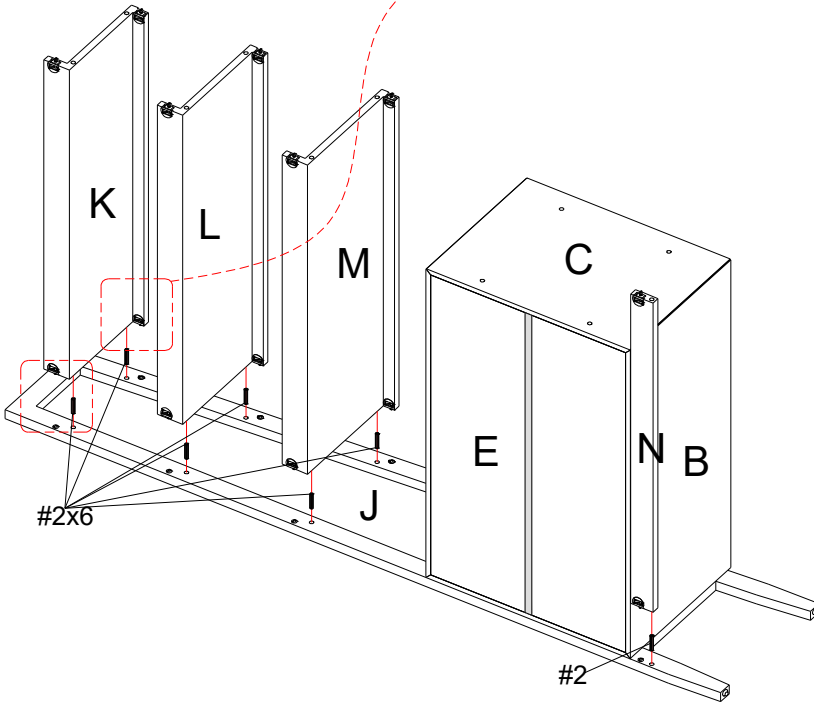
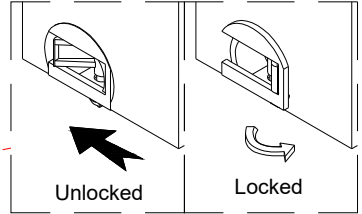



| #2 | x7 |
|---------|----|
| | |
| Ø8*30mm | |

ASSEMBLY INSTRUCTIONS

STEP-7

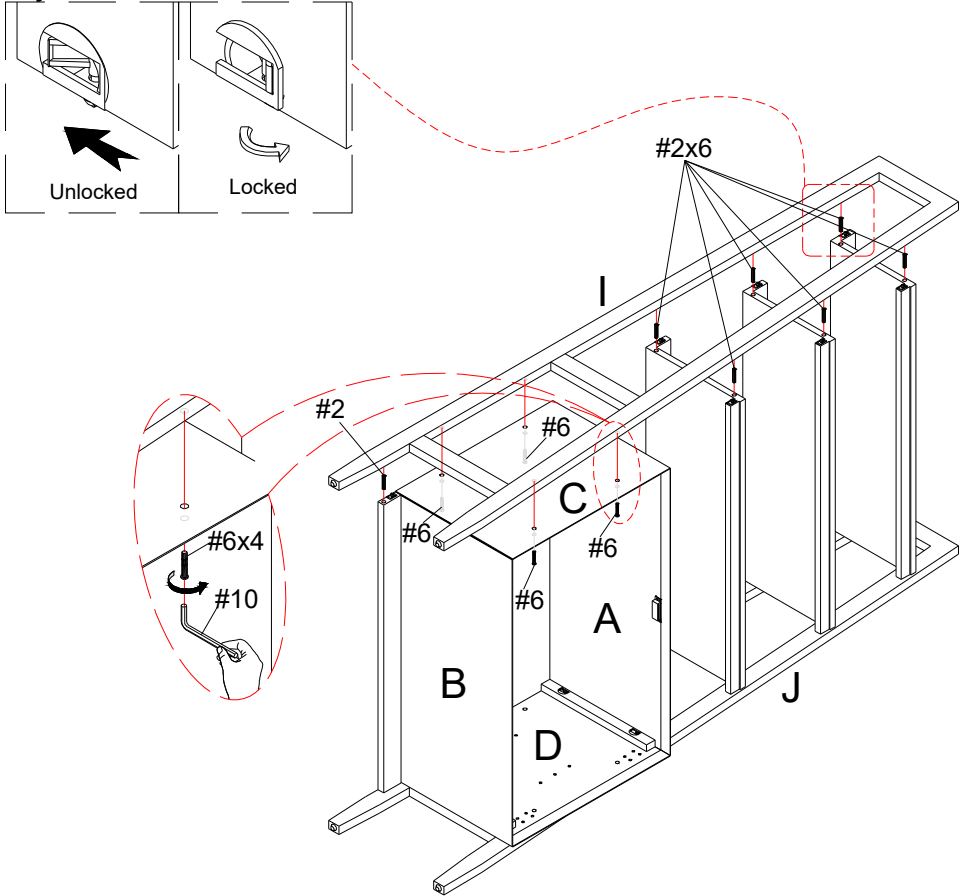
1. Attach the left leg (I) to the pre-assembled unit from step 6 using a #6 screw and wooden dowel #2 and tighten with a #10 Allen key, and lock the hardware.



| #10 | x1 |
|---|----|
|  | |
| M4 | |

| #2 | x7 |
|---|----|
|  | |
| Ø8*30mm | |



| #6 | x4 |
|---|----|
|  | |
| Ø1/4x1" | |

ASSEMBLY INSTRUCTIONS

STEP-8

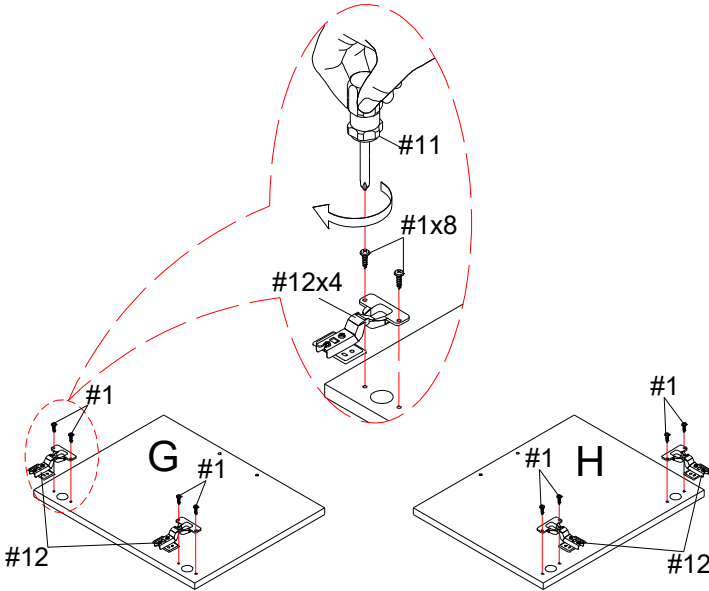
1. Use screw #1 to attach the hinges #12 to door panel (G)&(H), tighten screws with screwdriver #11.





| | | | | | |
|---|----|---|----|---|----|
| #11 | x1 | #12 | x4 | #1 | x8 |
|  | |  | |  | |
| M5 | | | | Ø3x12mm | |

ASSEMBLY INSTRUCTIONS

STEP-9

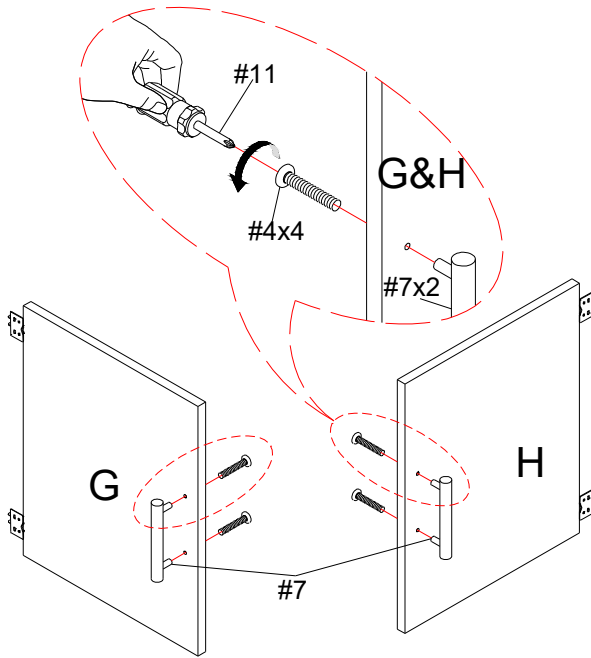
1. Use bolt #4 to attach handle #7 to door panel (G)&(H), tighten bolts with screwdriver #11.



| | |
|---|----|
| #7 | x2 |
|  | |

| | |
|---|----|
| #11 | x1 |
|  | |
| M5 | |

| | |
|--|----|
| #4 | x4 |
|  | |
| Ø5/32"*3/4" | |

ASSEMBLY INSTRUCTIONS

STEP-10

1. Insert shelf pin #8 into reassemble unit at step 7.
2. attach adjustable shelf (F) to pin #8.

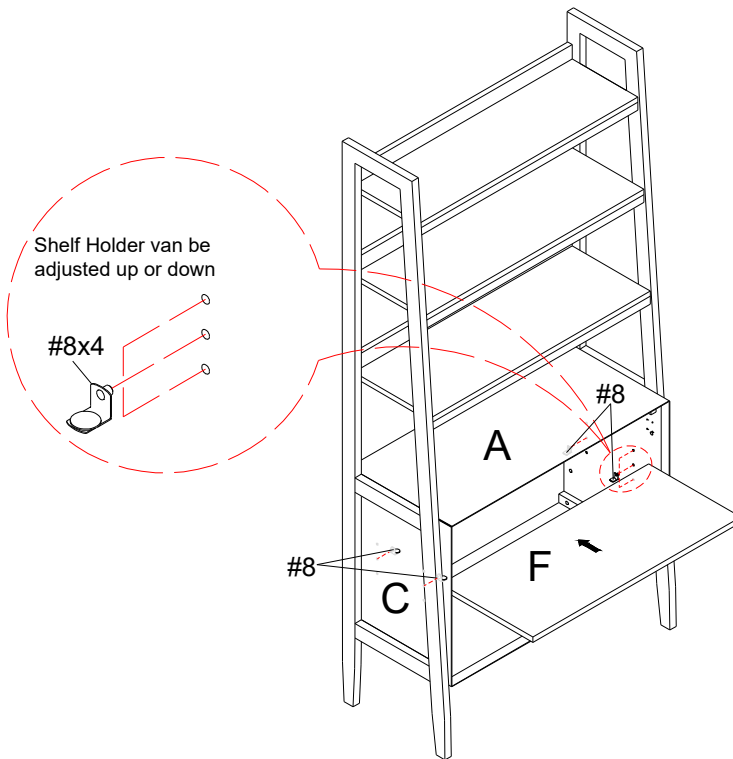



| #8 | x4 |
|--|----|
|  | |

ASSEMBLY INSTRUCTIONS

STEP-11

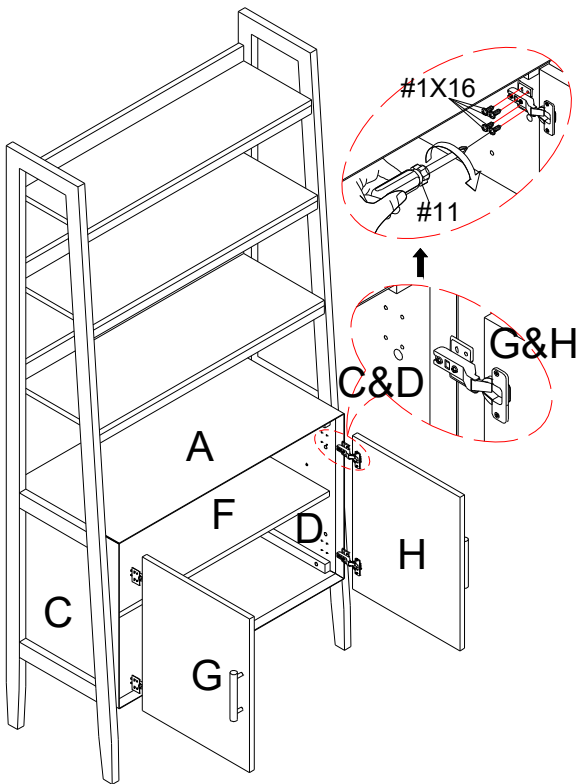
1. Use screw #1 to attach left door (G) and right door (H) to reassemble unit at step 10 ,tighten screw with screwdriver #11 .



| | |
|---|-----|
| #1 | x16 |
|  | |
| Ø3x12mm | |

| | |
|--|----|
| #11 | x1 |
|  | |
| M5 | |

ASSEMBLY INSTRUCTIONS

| | |
|---|----|
| #13 | x1 |
|  | |
| Safety Strap Kit | |

| | |
|---|----|
| A | x1 |
|  | |
| Ø1/4" | |

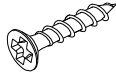
| | |
|---|----|
| B | x1 |
|  | |
| Ø4*1-1/2" | |

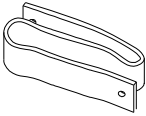
| | |
|---|----|
| C | x1 |
|  | |
| 1"*10-1/2" | |

| | |
|--|----|
| #11 | x1 |
|  | |
| M5 | |

STEP-12

1. Attach plastic strap C to shelf (K) using screw B and flat washer A, tighten screw with screwdriver #11.

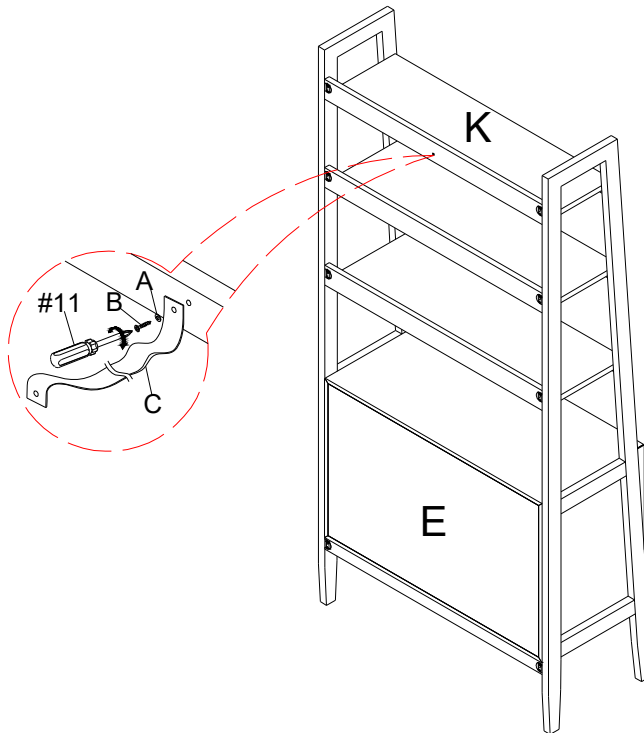



ASSEMBLY INSTRUCTIONS

| | |
|---|----|
| #13 | x1 |
|  | |
| Safety Strap Kit | |

| | |
|---|----|
| A | x1 |
|  | |
| Ø1/4" | |

| | |
|---|----|
| D | x1 |
|  | |

| | |
|---|----|
| E | x1 |
|  | |
| Ø4*3/4" | |

| | |
|--|----|
| #11 | x1 |
|  | |
| M5 | |

STEP-13

1. Install the anti-collapse device.
2. Mark the position on the wall, that corresponds to the location of plastic belt C on the back of panel K; Drill and insert the expandable screw D by hammer.
3. Assemble the plastic belt C to the wall. Align the hole in the plastic belt C with the expandable screw D, use bolt E and flat washer A to attach them and tighten by screwdriver #11.

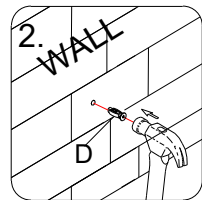
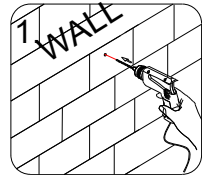
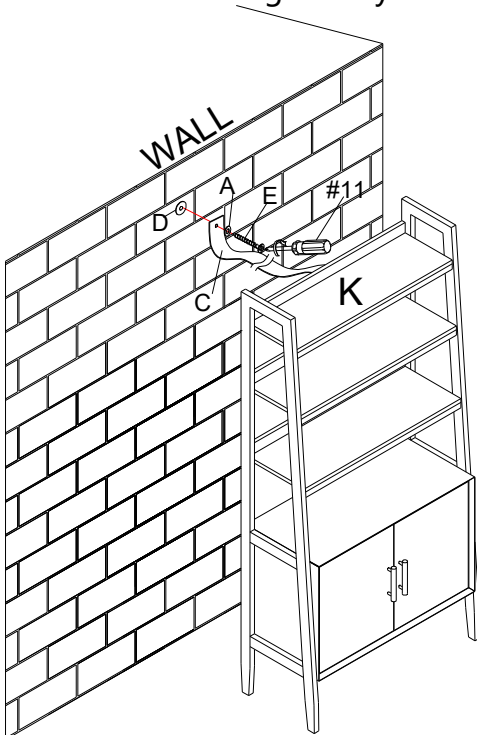

ASSEMBLY INSTRUCTIONS

Concealed hinges are three-way adjustable:

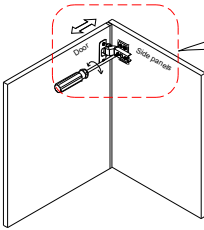

Horizontal
by screw adjustment!

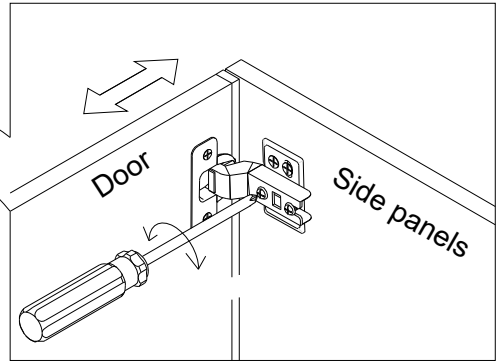

Concealed hinges are three-way adjustable:

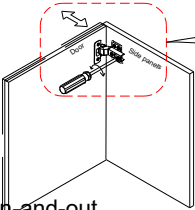

In-and-out
by loosening the hinge arm
mounting screw or via cam
adjustment!

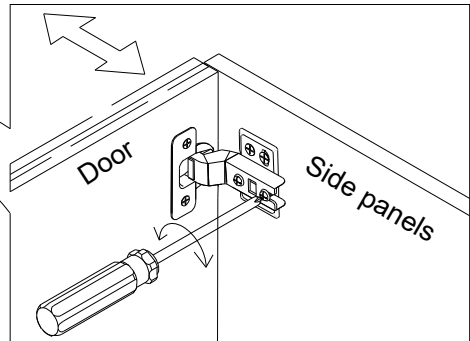

Concealed hinges are three-way adjustable:

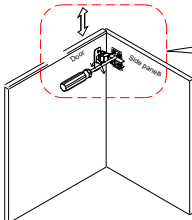

Vertical via slots
in the mounting plate
or via cam
adjustment!

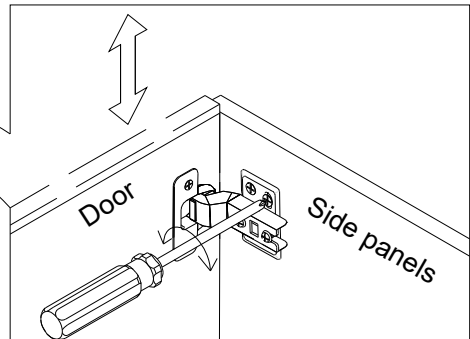

Hinge adjustment method

ASSEMBLY INSTRUCTIONS

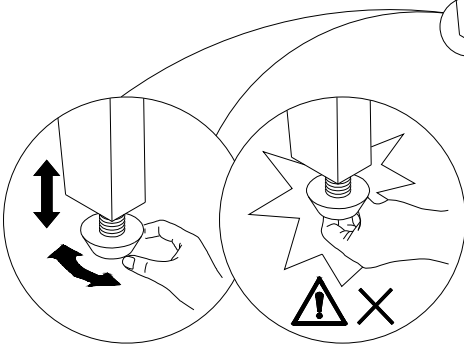
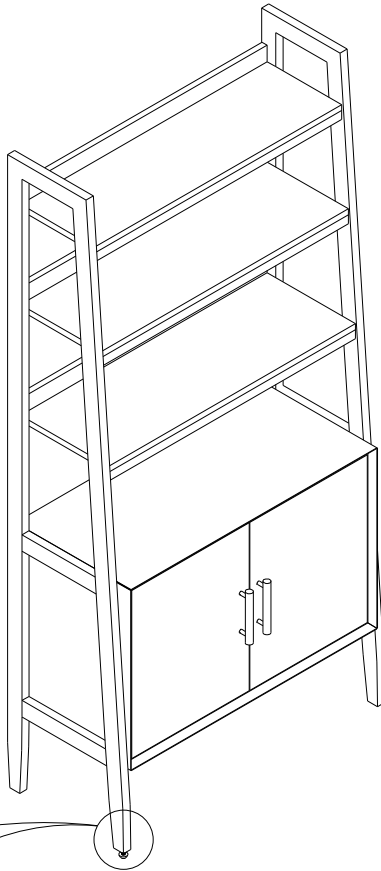

WARRANTY

1. We strive to offer high-quality products, and we also try our best to satisfy each and every customer that orders from us with product or service as needed.
2. We provide 30 days warranty starting from the time you receive the item. Each customer must provide a record of their order such as the order number, or item receipt for any items that are out of the warranty period you may also still receive.
3. Replacement parts by purchasing them with our company if they are available.

Are you having difficulty
With assembly? Missing parts?
Please send email with your order No to
customerservice@hulalahome.com
For return, please check the return policy with
the retailer or market place you bought from.

Appreciate your purchasing from us.
Pop up your life by our furniture piece!