

NurseryNook™
by HULALA
HOME

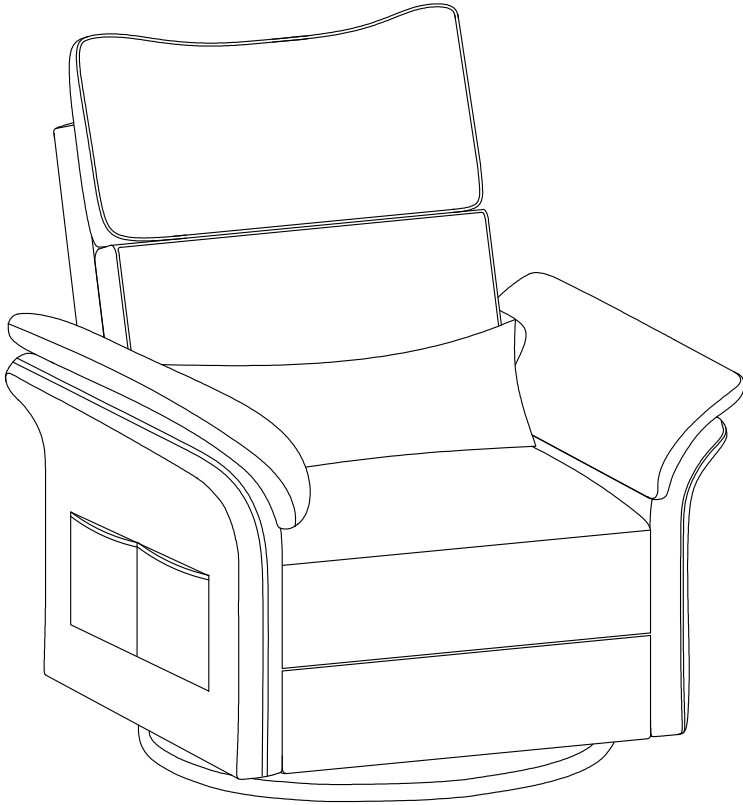

ITEM NO. RCLB1070

NOTE:

This brochure contains IMPORTANT safety info. Please read and keep for future reference.

Maintenance and Warning

- We suggest you spend a short time reading through this leaflet and then follow the simple step-by-step instructions.
- Carefully check that you have all the parts before beginning assembly.
- Keep fittings out of children's reach and keep children well away from construction area.
- We suggest you retain these instructions for future reference.
- Keep furniture away from heat sources.
- Do not clean furniture with harsh cleaners or polishes.
- Do not use detergents, solvents, abrasives, spray packs or leather cleaners.
- Use non-color mild soap with warm water to clean spills (Mix 1:10 soap to water).
- Do not place furniture under direct sunlight, material will possibly fade over time.
- Do not use an on-site dry cleaning machine.
Children should not climb or jump on the furniture.
- Do not write on furniture that is not protected by a padded barrier.
- Not for commercial use, only for residential use.

Parts List

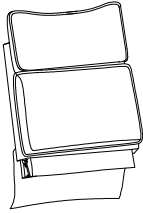

A Backrest x 1

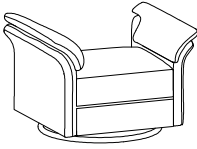

B Seat Cushion x 1



C Lumbar Pillow x 1

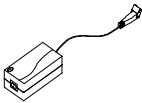

D Adapter x 1



E Plug x 1

ASSEMBLY INSTRUCTION

Step 1

Open the package and cut the holding string.

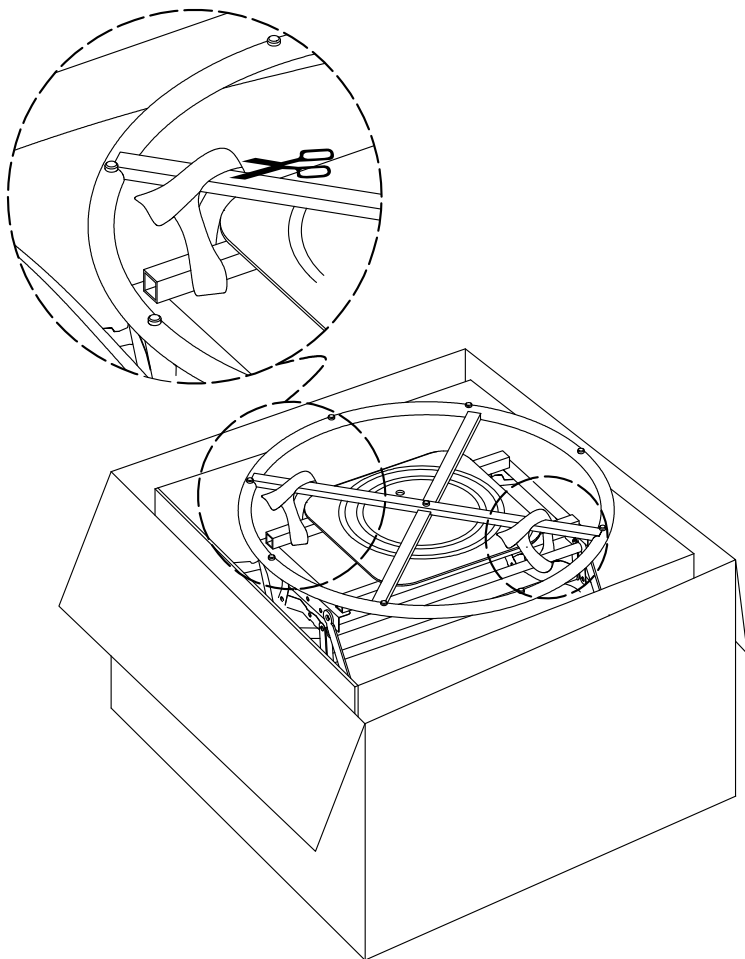

Step 2

Connect A and B through zippers.

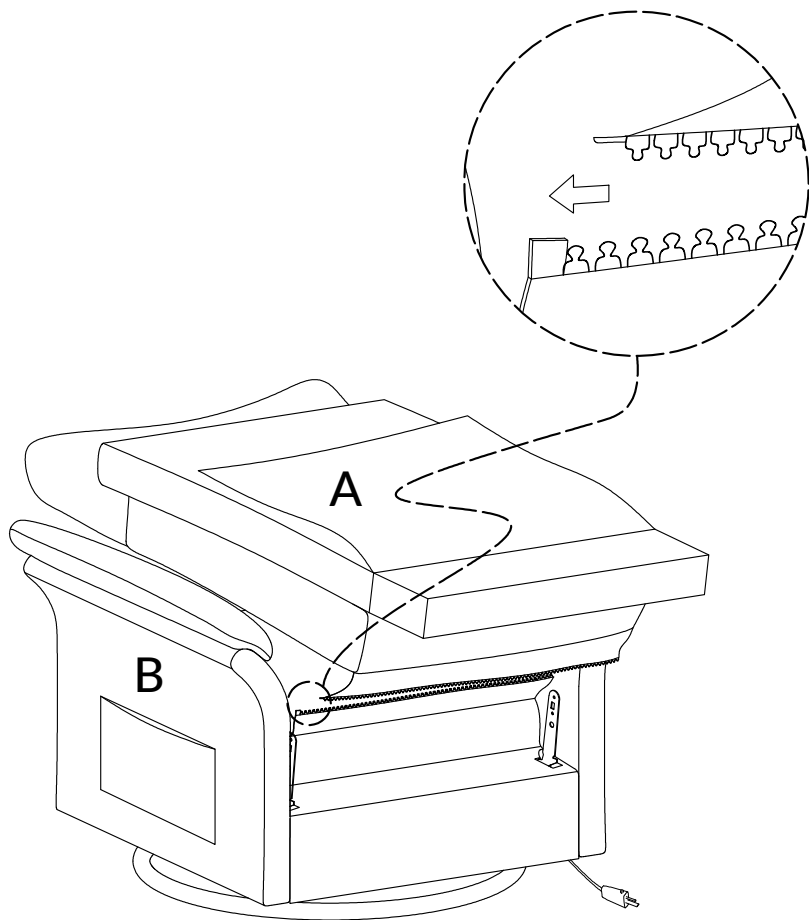

Step 3

Hold both armrests while aligning metal brackets on backrest or armrests.



NOTE:

Be sure to have an adult partner help.

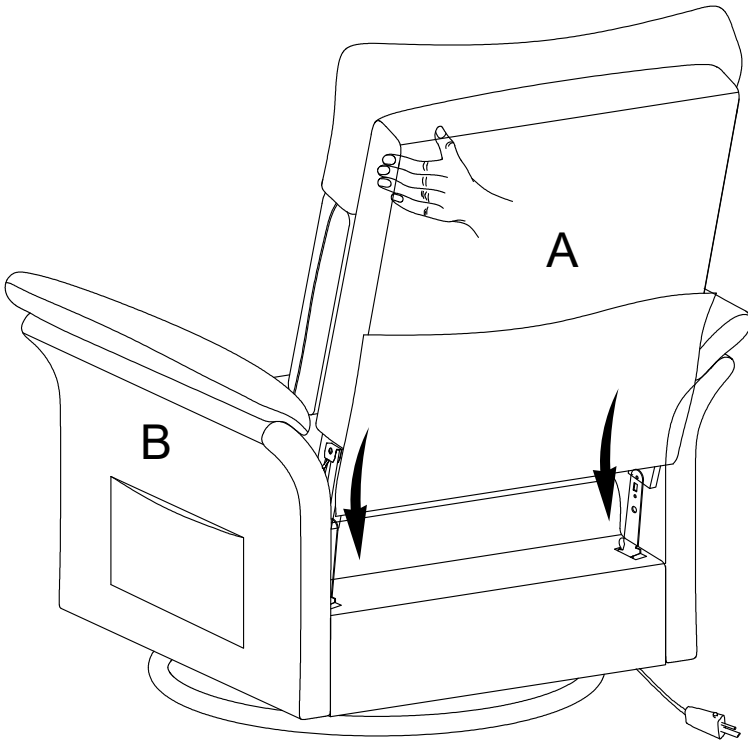

Step 4

Cover the back cloth.

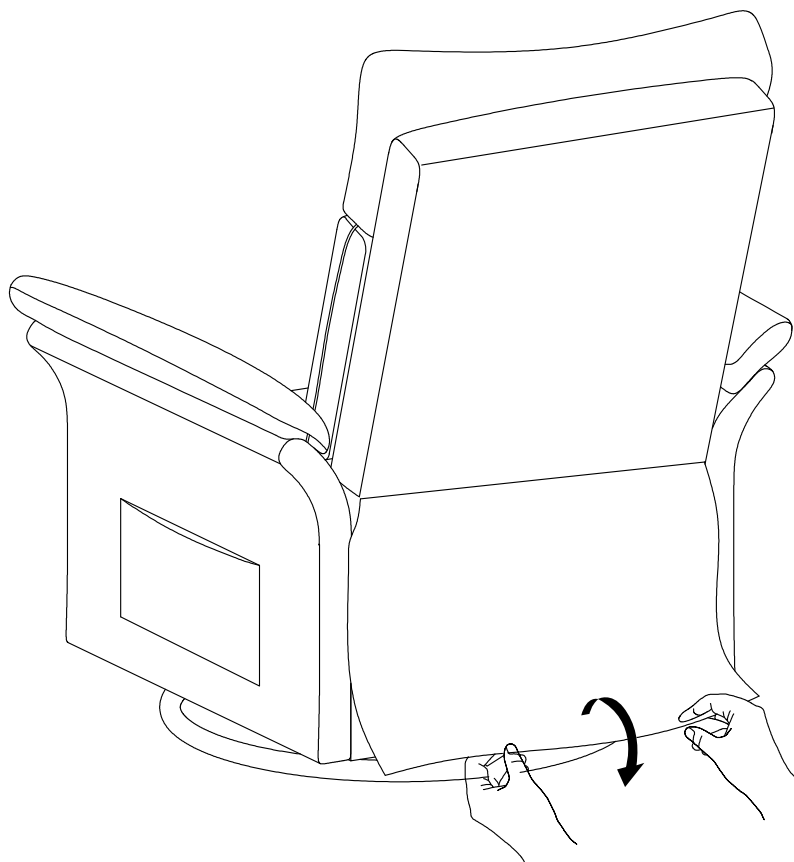

Step 5

Place the lumbar pillow on the cushion.

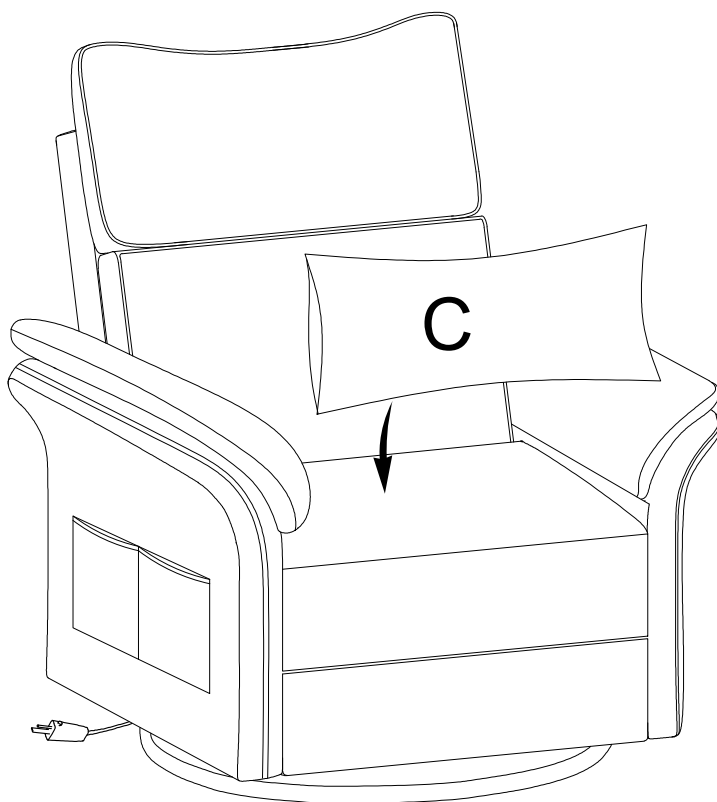

Step 6

Connect the power cord.

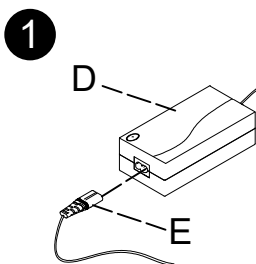
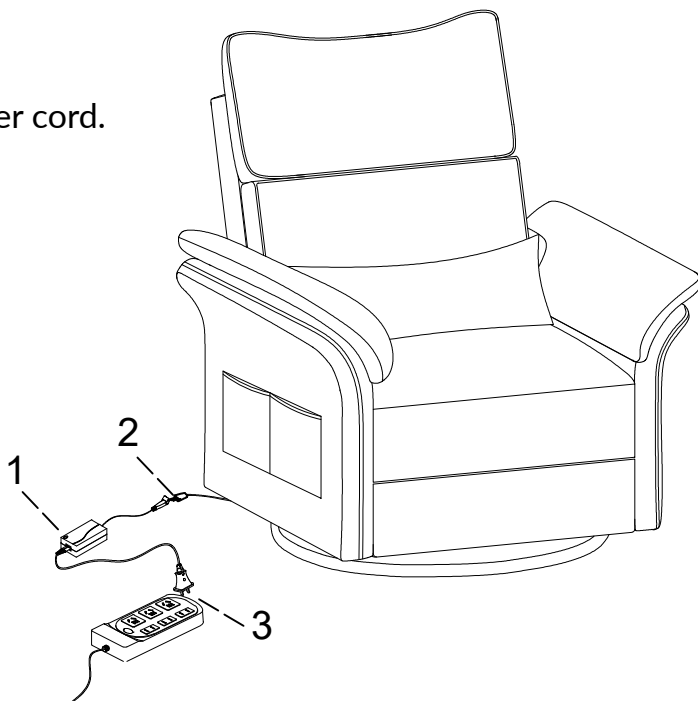

Connect D and E.

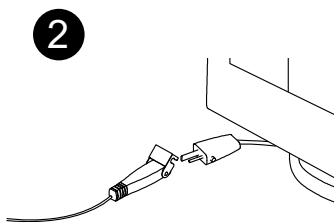

Connect the adapter cable to the bottom cable of the sofa.

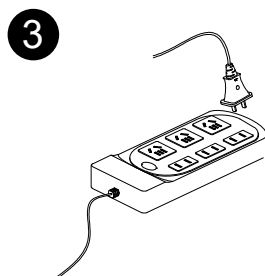

Power on the plug.

Adjust the Angle through Buttons

The backrest can be tilted from 105 to 135 degrees.

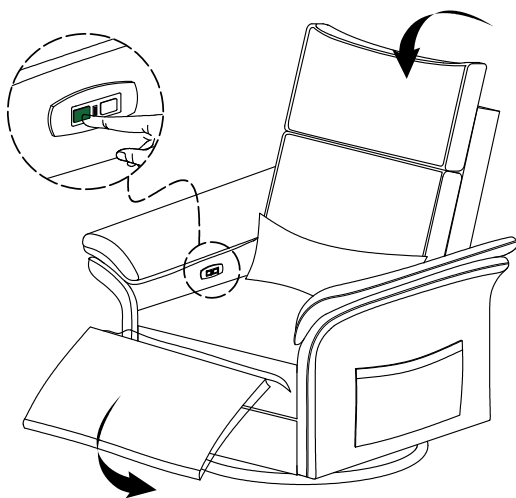
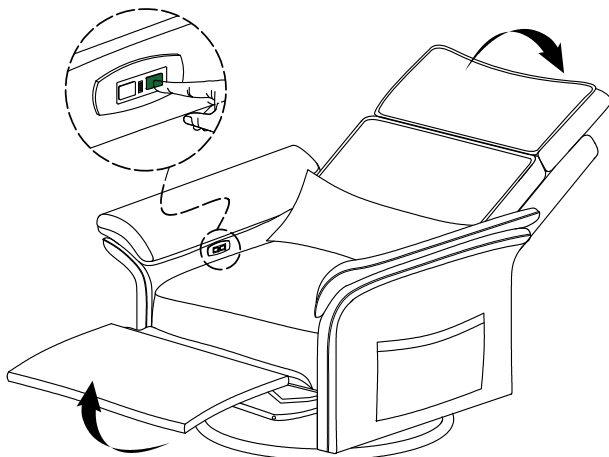

Adjustable Headrest

Firmly move both ends backwards to engage the locking mechanism.

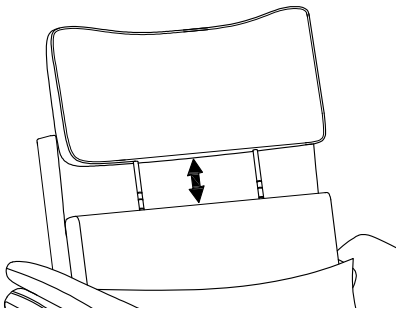
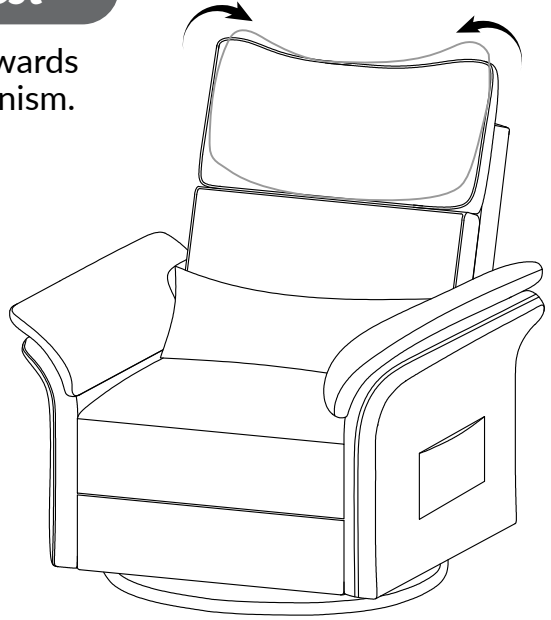

Gently pull each end to the desired angle.

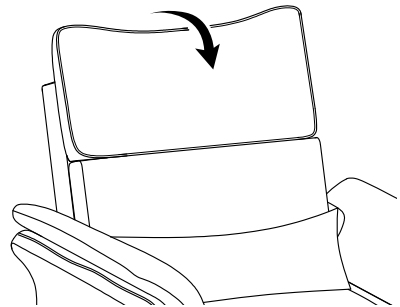

Tilt back and forth to find a comfortable angle.

Adjustable Armrest

Step 1: Firmly lift the armrest beyond the max angle and stop hearing the mechanism's clicks.

Step 2: Firmly push all the way down to engage the locking mechanism.

Step 3: Left armrest to the desired height.



240-degree Swivel Base

It offers a cozy spot for feeding, soothing, and relaxation.

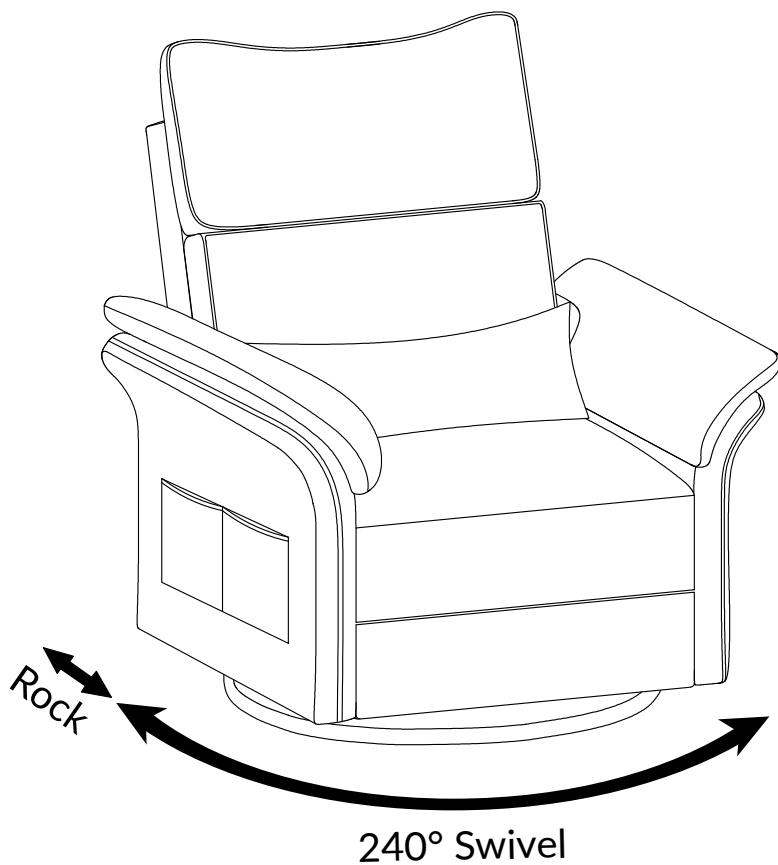

MATTERS NEEDING ATTENTION

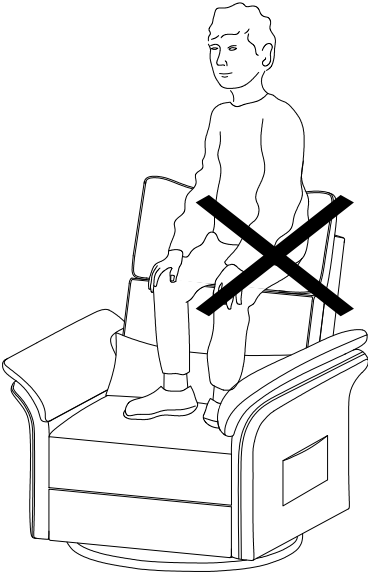

NOTE:
Do not sit on the backrest!



NOTE:
Do not sit on the armrest!

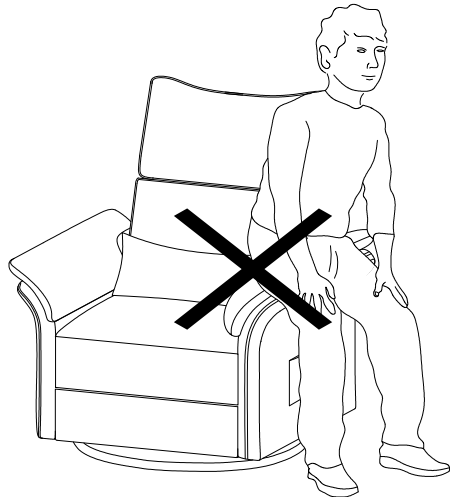



NOTE:
Do not sit on the foot pedal!

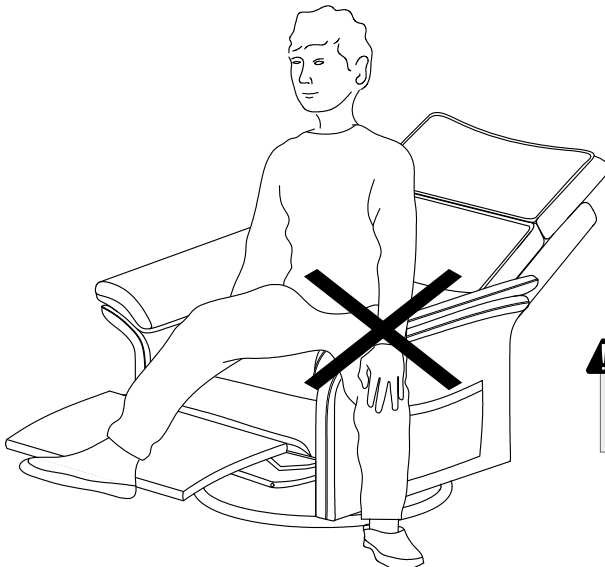
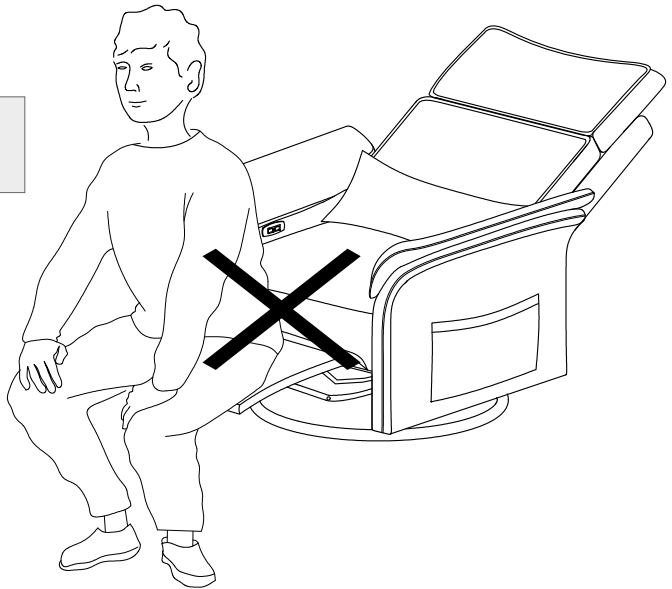

NOTE:
Do not place legs on handrails!

WARRANTY

- We strive to offer quality products, and we also try our best to satisfy every customer who orders from us with products or services as needed.
- We provide 30 days warranty starting from the time you receive the item. Each customer must provide a record of their orders such as the order number, or item receipt for any items that are out of the warranty period you may also still receive.
- Replacement parts by purchasing them from our company if they are available.

Are you having difficulty

With assembly? Missing parts?
Please send an email with your order No. to
customerservice@hulalahome.com

For return, please check the return policy with the retailer or market place you bought from.

***Appreciate your purchasing from us.
Pop up your life by our furniture piece!***