

# HULALA

---

H O M E

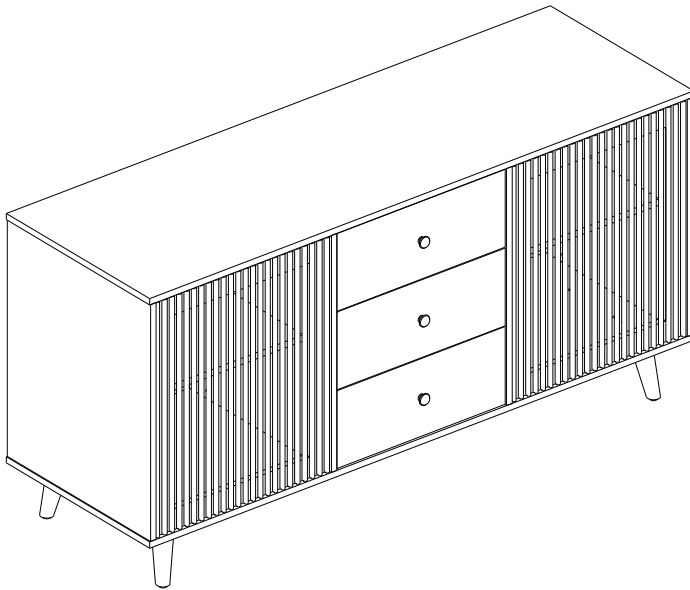

**ITEM NO.TVYJ0746**

---

## NOTE:

This brochure contains IMPORTANT safty info. Please read and keep for future reference.

---

# MAINTAINANCE AND WARNING

- Keep furniture away from heat sources.
- Do not clean furniture with harsh cleaner or polishes. Do not use detergents, Solvents, abrasives, spray packs or leather cleaner. Use non-color mild soap with warm water to clean spills (Mix 1:10 soap to water)
- Do not place furniture under direct sunlight, material will possibly fade over time.
- Do not use on site dry Cleaning machine. Children should not climb or jump on the furniture.
- Do not write on furniture that is not protected by a padded barrier .
- Not for commercial use, only for residential use.







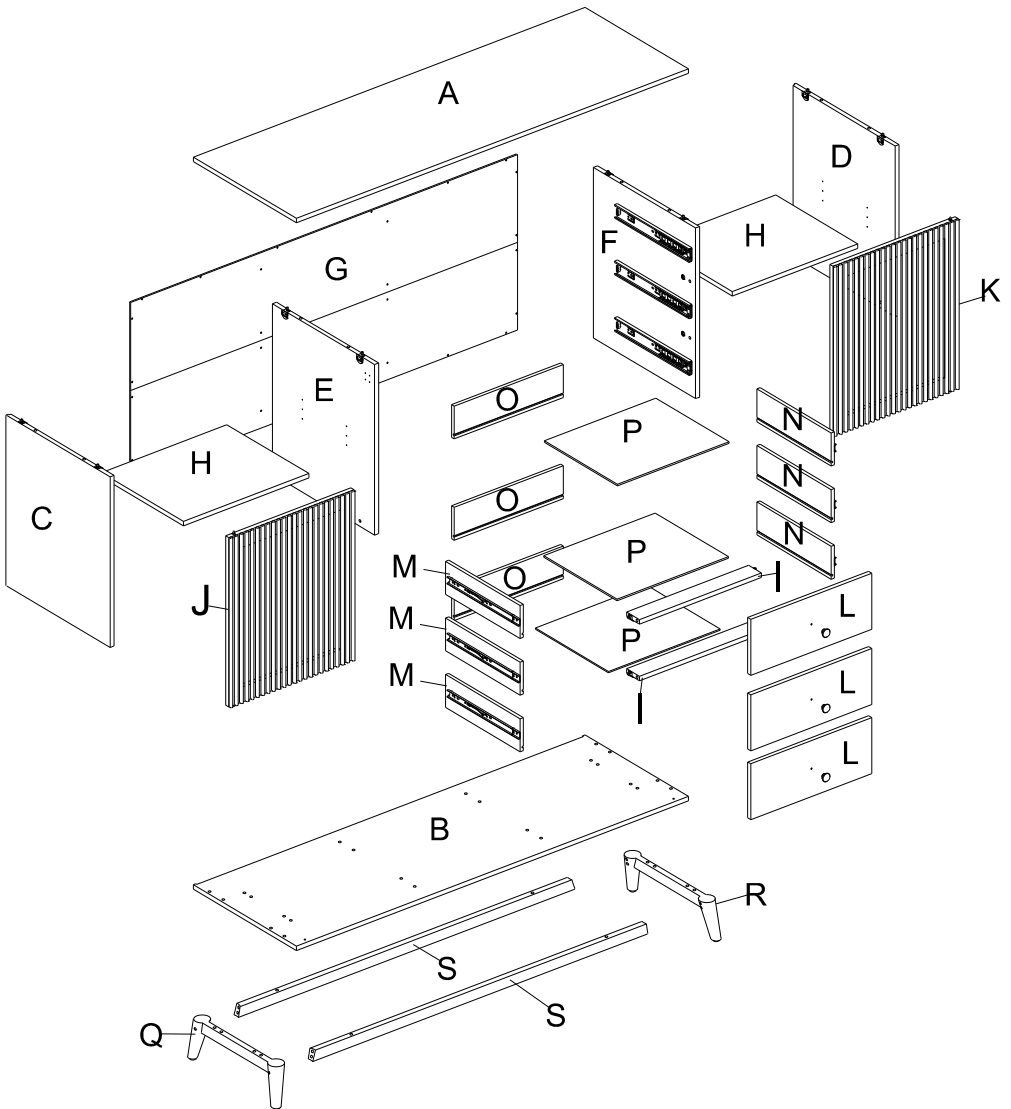





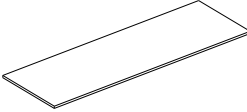
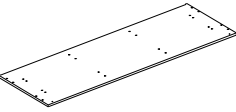
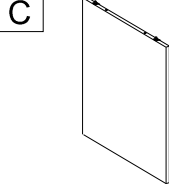
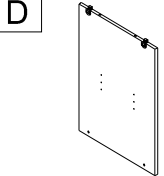
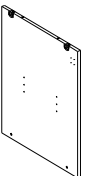

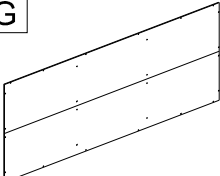
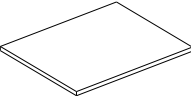
Weight Limitation

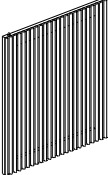
**100LBS**

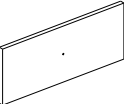

# OVERVIEW

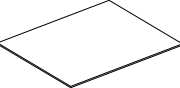

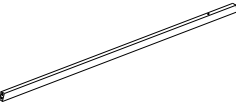

# HARDWARE LIST

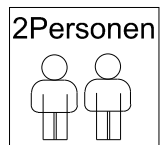
<b>A</b> 	<b>B</b> 	<b>C</b> 	<b>D</b> 
1 PC	1 PC	1 PC	1 PC
<b>E</b> 	<b>F</b> 	<b>G</b> 	<b>H</b> 
1 PC	1 PC	1 PC	2 PCS
<b>I</b> 	<b>J</b> 	<b>K</b> 	<b>L</b> 
2 PCS	1 PC	1 PC	3 PCS
<b>M</b> 	<b>N</b> 	<b>O</b> 	<b>P</b> 
3 PCS	3 PCS	3 PCS	3 PCS
<b>Q</b> 	<b>R</b> 	<b>S</b> 	
1 PC	1 PC	2 PCS	





Persons Required For Assembly:



# PARTS LIST 1





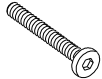

①	x8	②	x12	③	x32	④	x3	⑤	x28
			∅6		∅8				

# SPARE

①	x1	②	x1	③	x1	④	x1	⑤	x1
			∅6		∅8				
⑥	x1								
									

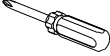

Be sure to inspect all packing material carefully for small parts, that may have come loose inside the carton during shipment.

# PARTS LIST 2

⑥	x20	⑦	x3	⑧	x8	⑨	x1	⑩	x1
									
⑪	x2	1#	x1						
									
		Safety Strap Kit							

Be sure to inspect all packing material carefully for small parts, that may have come loose inside the carton during shipment.

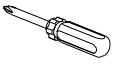
# ASSEMBLY INSTRUCTIONS

⑩	x1	①	x8	⑪	x2
					

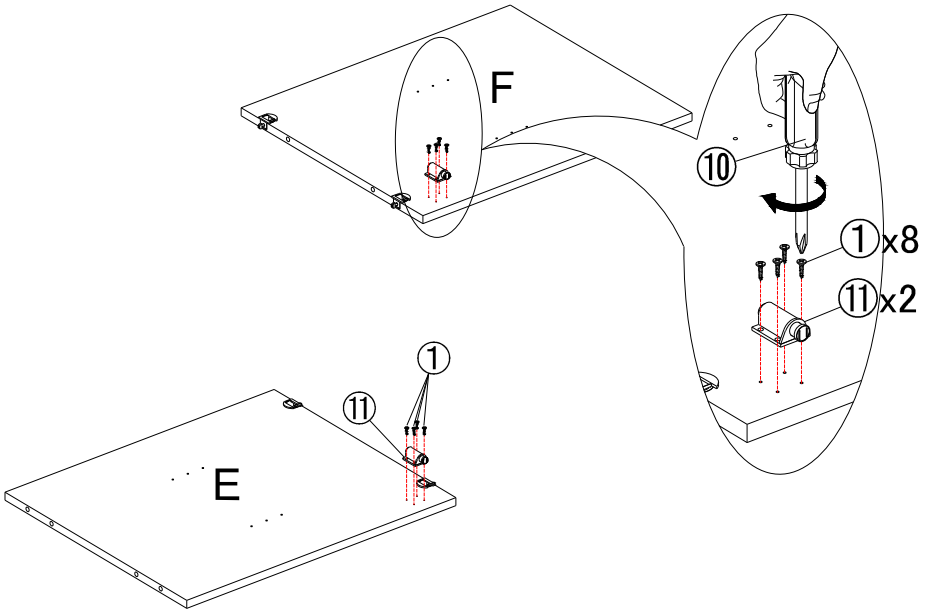

## STEP1:

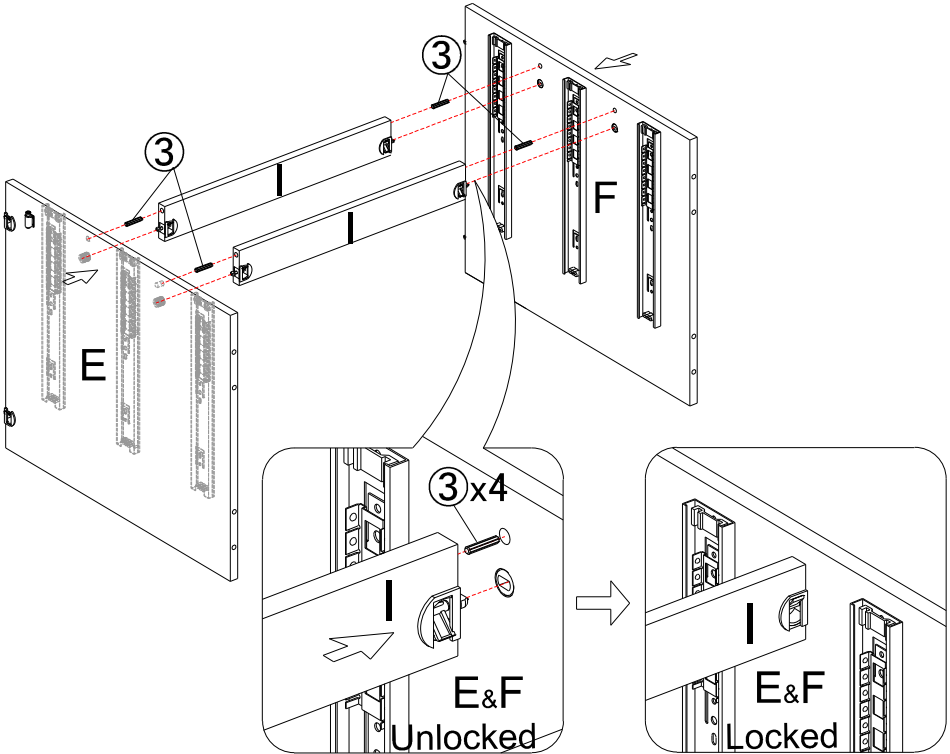
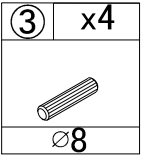

Use screw ① to attach part ⑪ to panel (E)&(F), tighten it with screwdriver ⑩.



## STEP2:

Insert wooden dowel ③ into part (I), and then insert middle vertical panel (E)&(F) into part (I), finally pull the combiner to lock it.



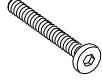

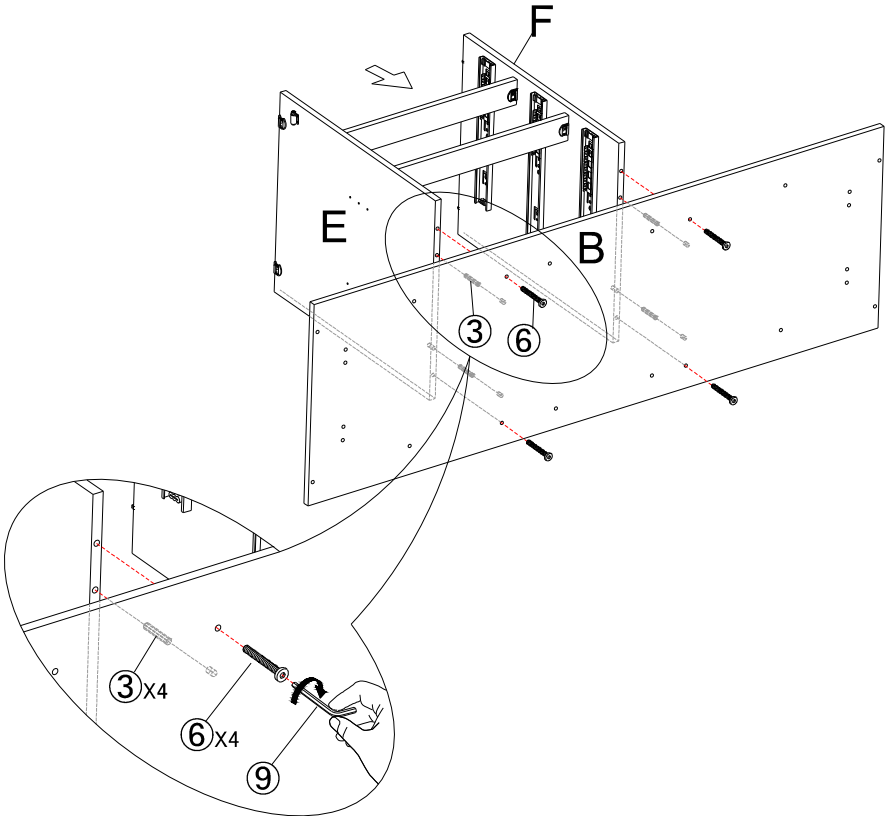
③	x4	⑨	x1	⑥	x4
					
∅8					



### STEP3:

Insert wooden dowel ③ into bottom panel (B), and then Use bolt ⑥ to attach bottom panel (B) to the preassembled unit at step 2, tighten bolt with allen key ⑨.

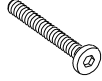
③	x4	⑨	x1	⑥	x4
					
∅8					

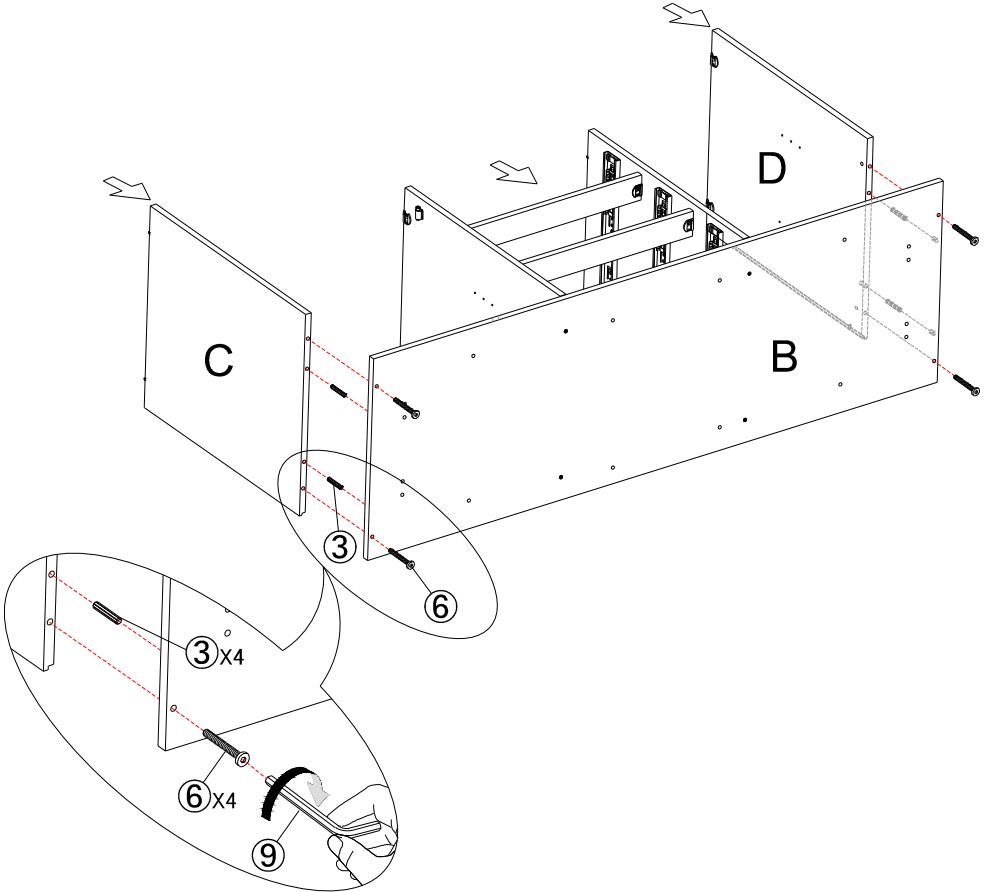

## STEP4:

Insert wooden dowel ③ into bottom panel (B),and then insert side panel (C)&(D)into bottom panel (B),use bolt ⑥ to attach bottom panel (B) to side panel (C)&(D),tighten it with allen key ⑨.

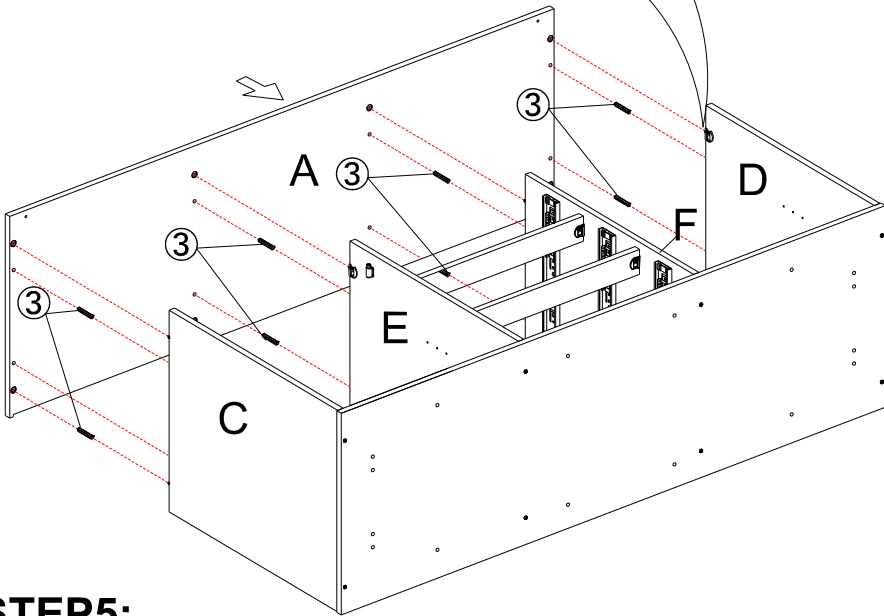
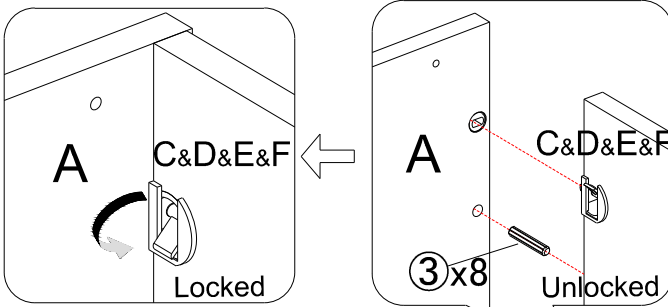
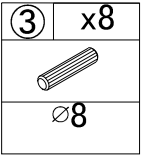

## STEP5:

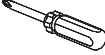

Insert wooden dowel ③ into preassembled unit at step 4, and then insert top panel (A) into preassembled unit at step 4, make sure all holes aligned and pull the combiner to lock it.

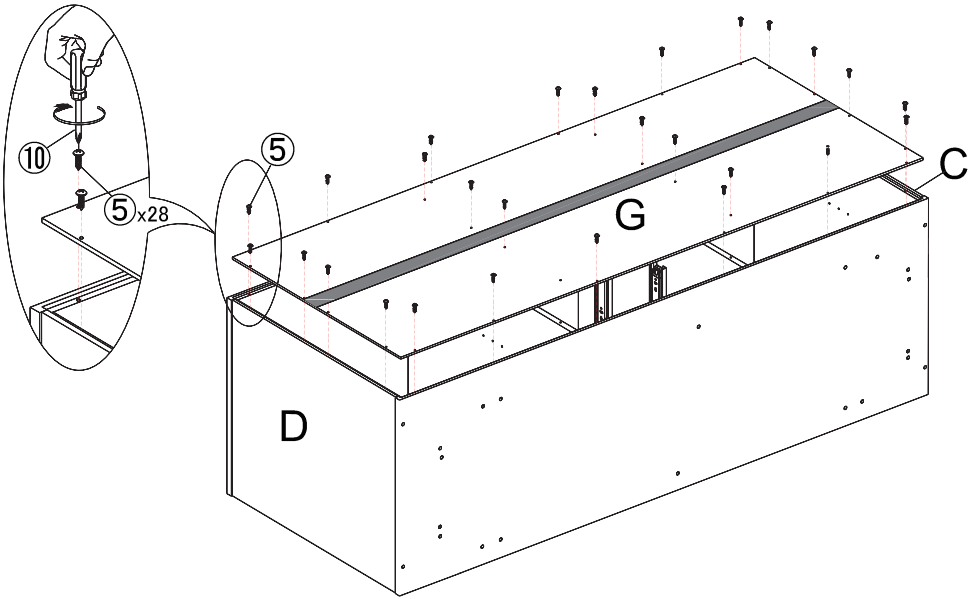
⑤	x28	⑩	x1
			



## STEP6:

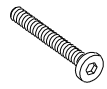

Attach back panel (G) to preassembly unit at step7 with screw ⑤, and tighten it with screwdriver ⑩.

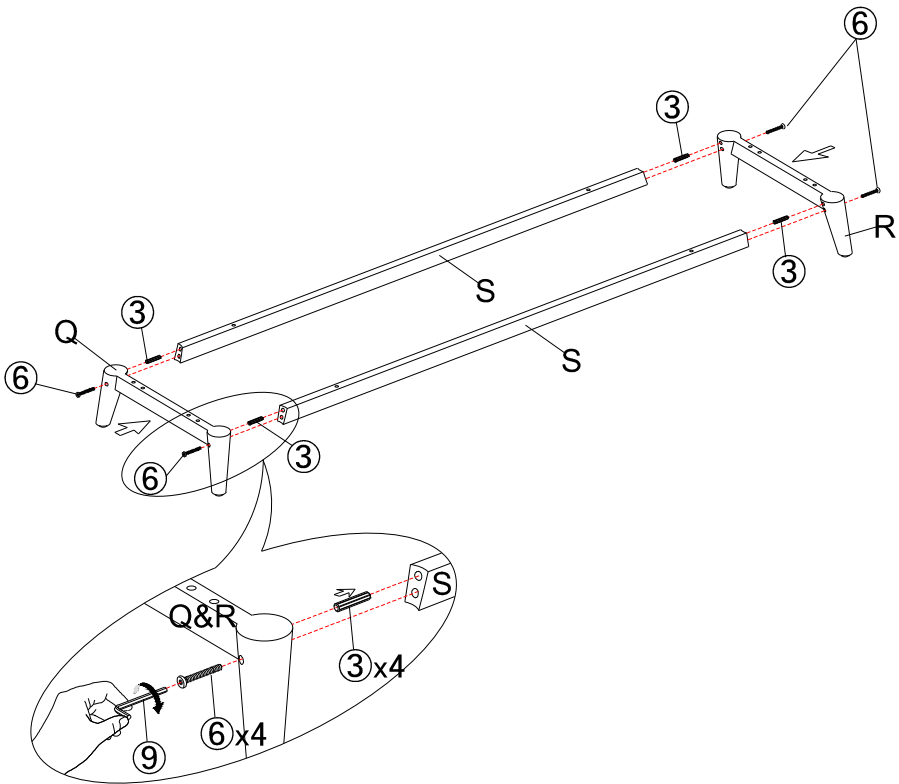
③	x4	⑨	x1	⑥	x4
					
∅8					



## STEP7:

Insert wooden dowel ③ into part (S),and then insert leg (Q)&(R)into part (S),use bolt ⑥ to attach leg (Q)&(R) to part(S),tighten bolt with allen key⑨.

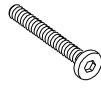
③	x8	⑨	x1	⑥	x8
					
∅8					

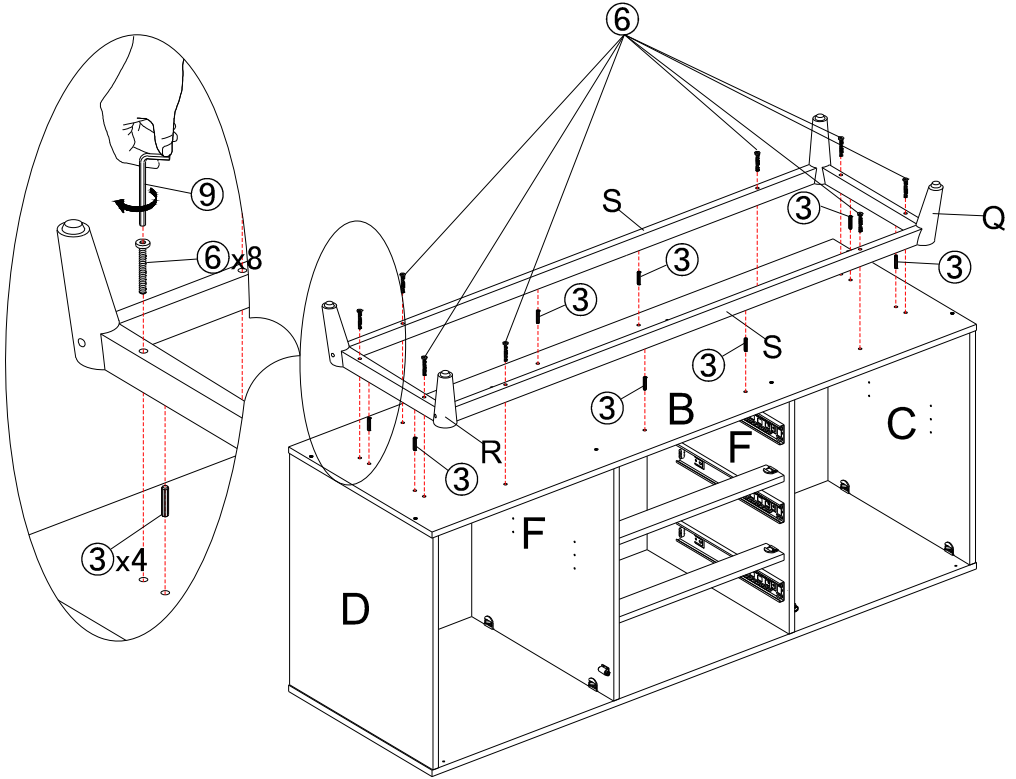

**STEP8:** Insert wooden dowel ③ into the corresponding hole of bottom panel(B), and then insert preassembled step 6 into bottom panel (B), use bolt ⑥ to attach them , tighten bolt with allen key⑨.

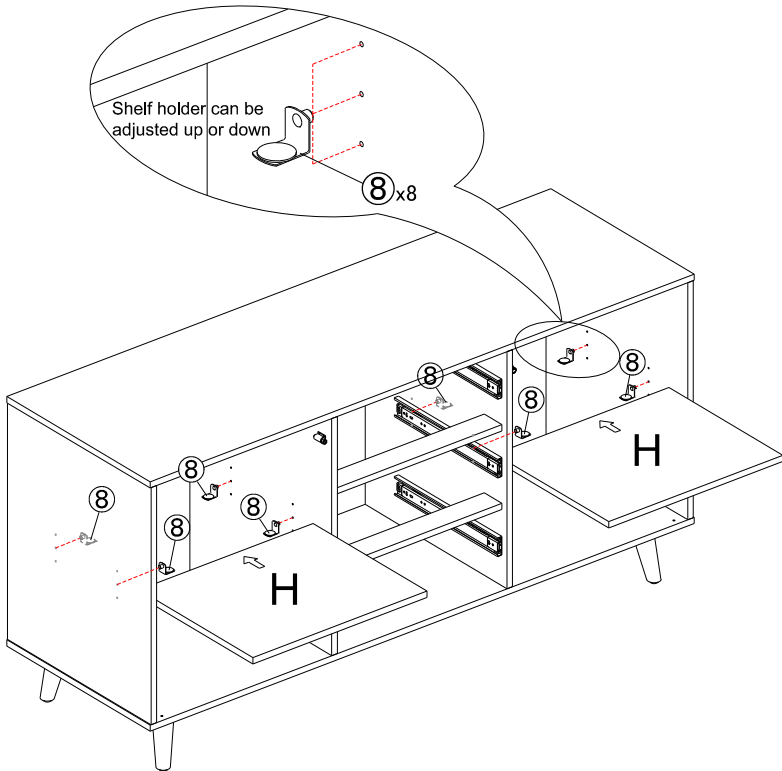
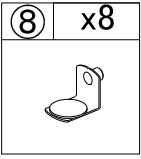

## STEP9:

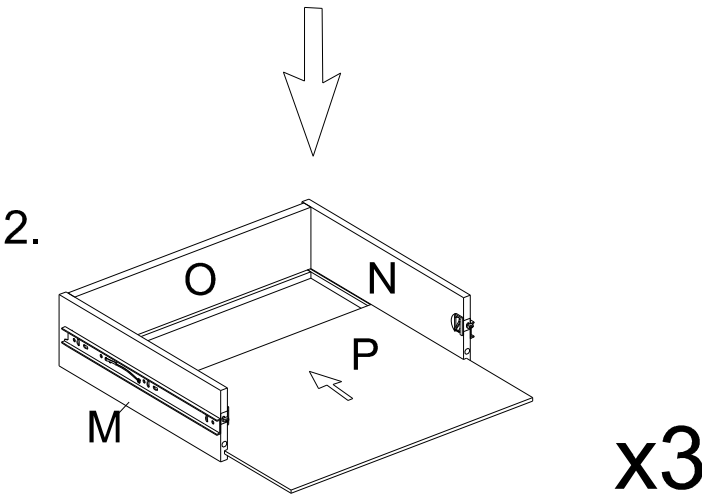
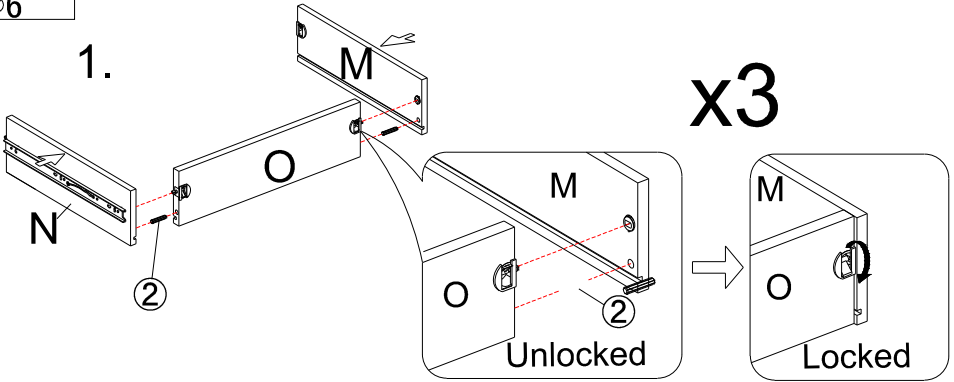
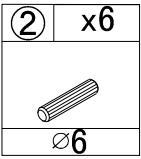

Insert shelf pin ⑧ into preassemble unit at step 8, and attach adjustable shelf (H) to it.



## STEP10:

Insert wooden dowel ② into drawer back panel (O) and insert drawer side panel (M) & (N) into back panel (O), and then pull the combiner to lock it, finally carefully align and slide panel (P) into the groove along rear edge of pre-assembled step 10.1.

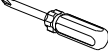

②	x6	⑦	x3	④	x3	⑩	x1
							
∅6							

1.

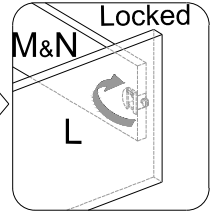
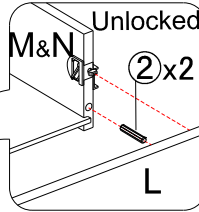
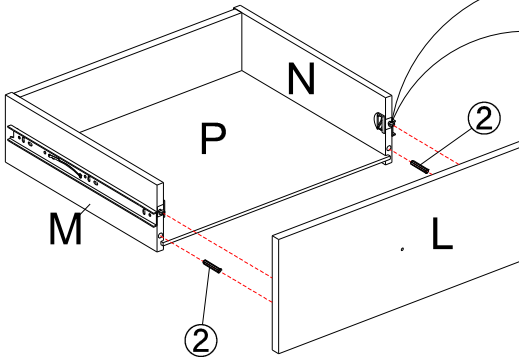

x3

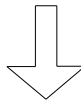

2.

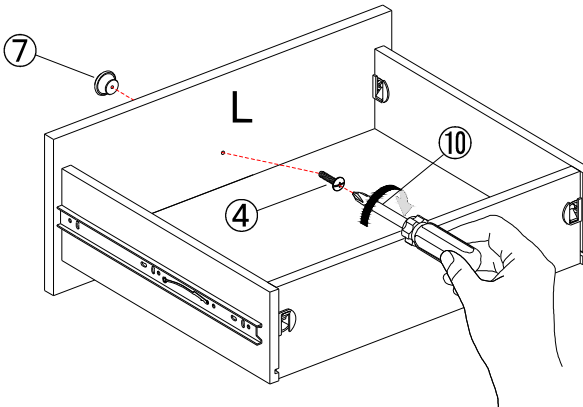

x3

### STEP11:

Insert wooden dowel ② into preassembled step 10.2, and then insert drawer front panel(L) into preassembled step 11.1, and then use bolt ④ to attach handle ⑦ to drawer front panel (L)



Attention: When installing the drawer, slide the steel ball slide rail of side panel to the most front as picture show.

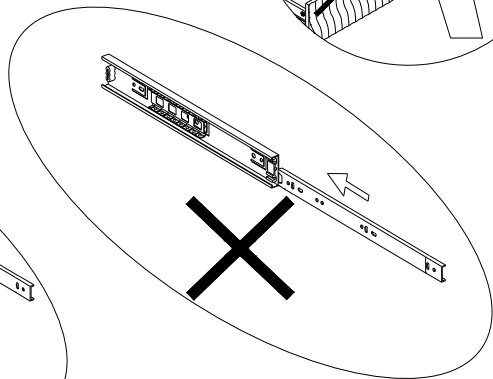
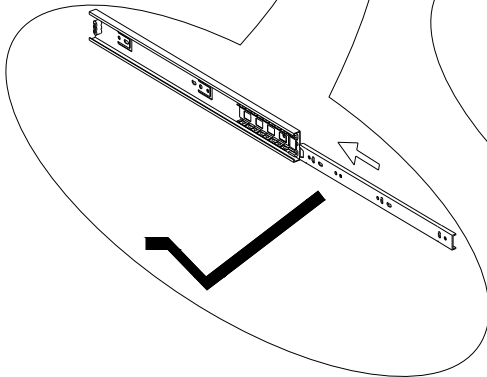
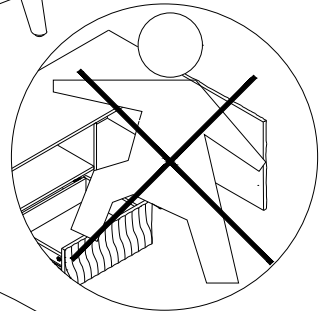
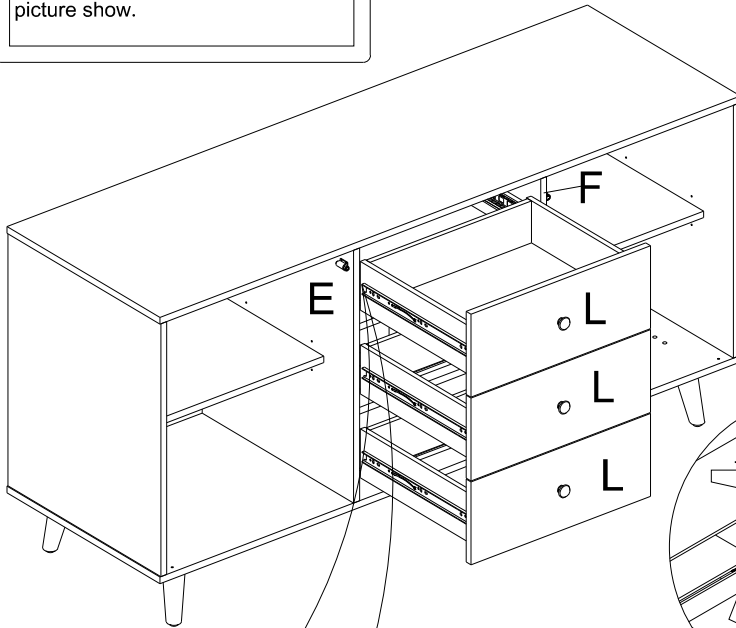

## STEP12:

Attention: When installing the drawer, slide the steel ball slide rail of side panel to the most front as picture show.

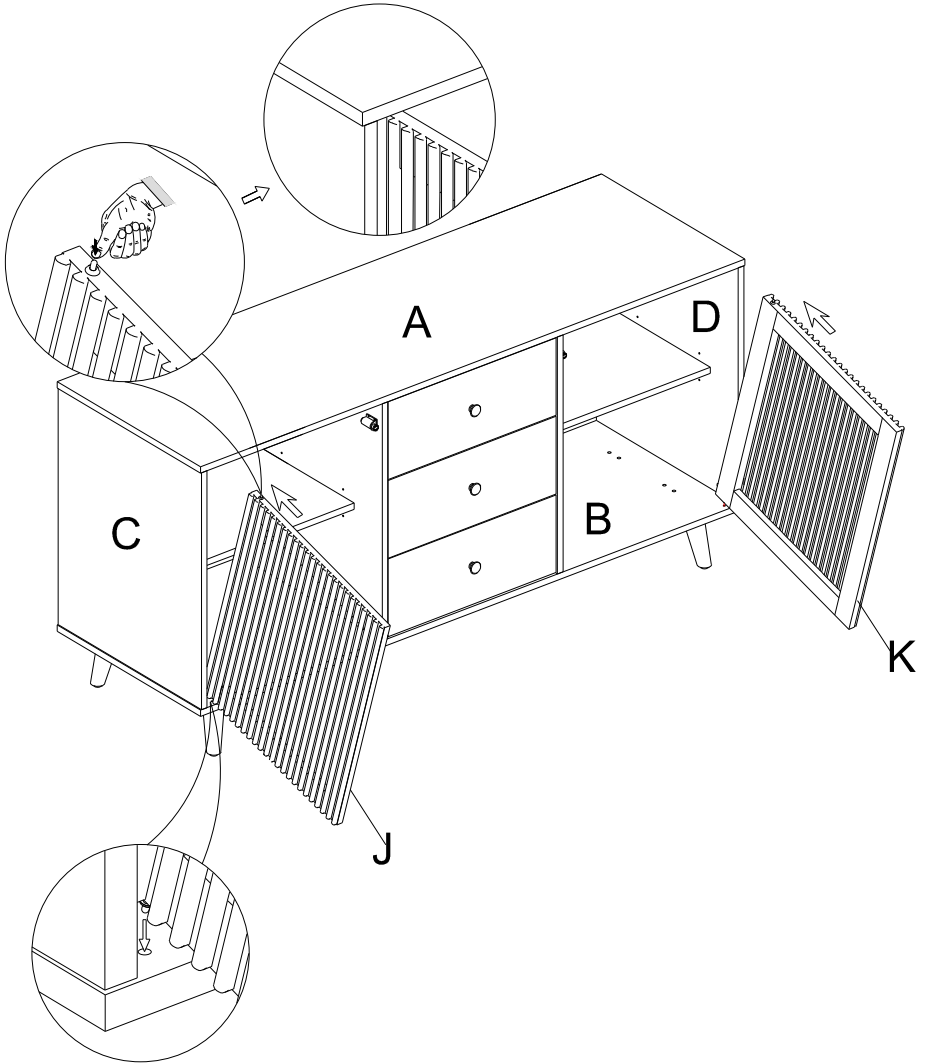

### **STEP13:**

First, align the salient point of the lower end door spindle (J)&(K) with the corresponding hole of bottom panel(B), and then press the upper end salient point of door spindle (J)&(K) with hand, finally push it forward to the corresponding hole of top panel (A).

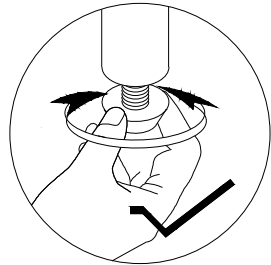
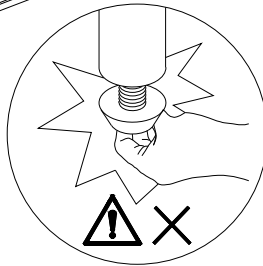
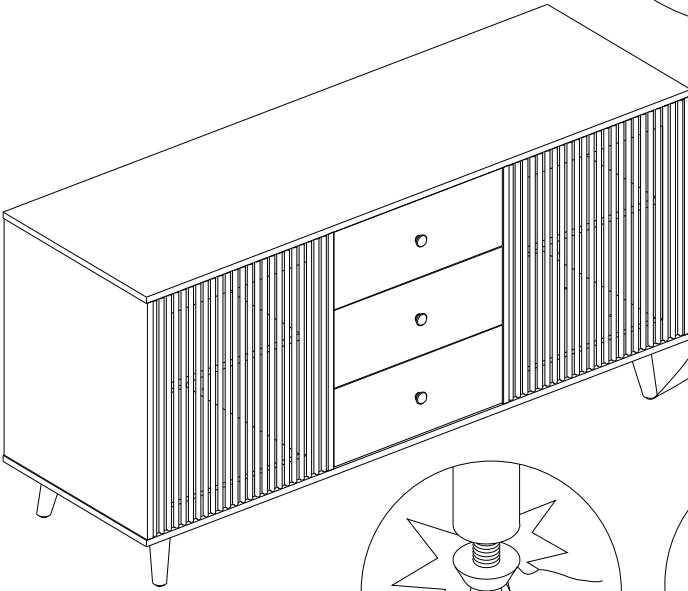
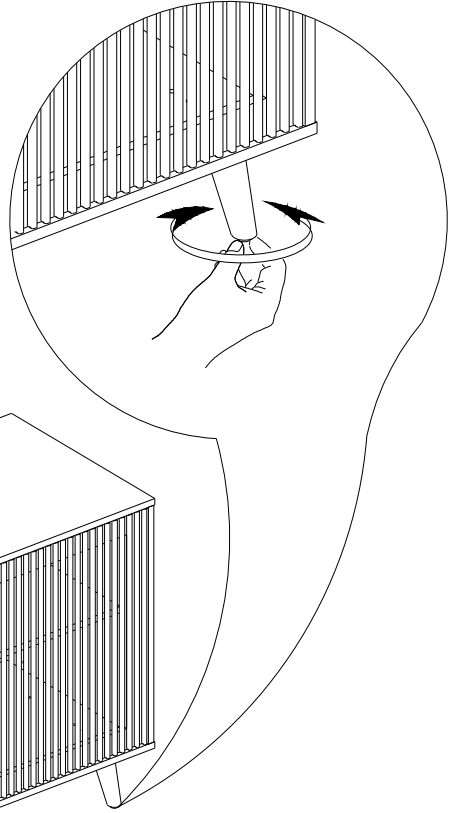

**Attention:**  
After installation, adjust the adjustable leveler to keep the cabinet balanced .



## **STEP14:**

Attention:



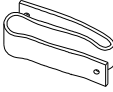
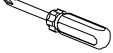

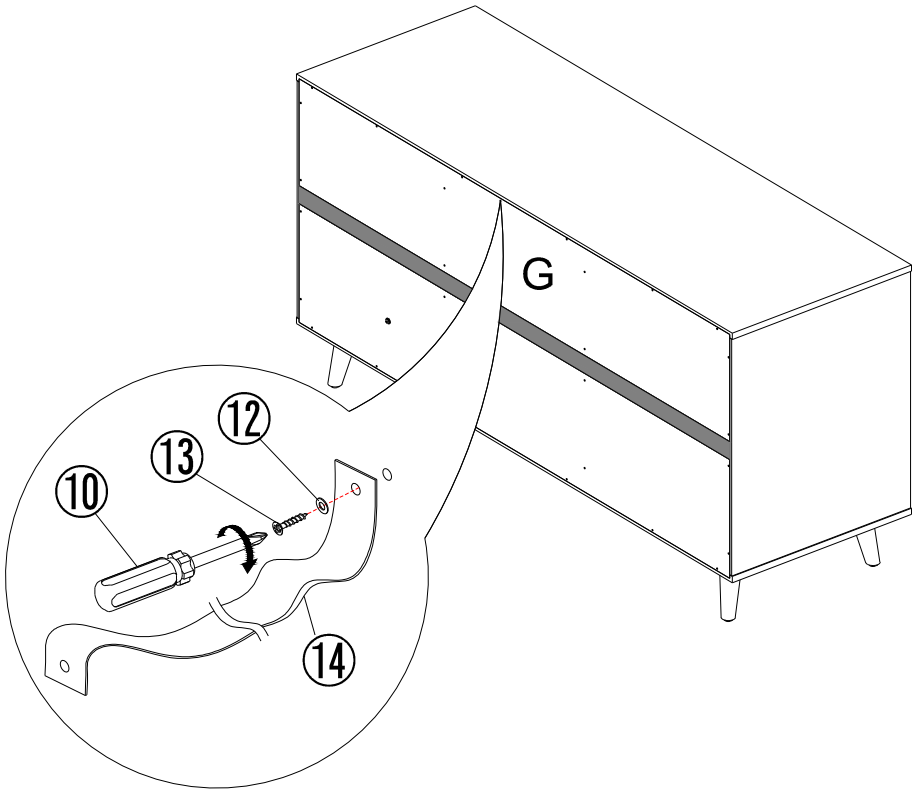
After installation, adjust the adjustable leveler to keep the cabinet balanced .

1#	x1	⑫	x1	⑬	x1	⑭	x1	⑩	x1
									
Safety Strap Kit									



## STEP15:

Use screw ⑬ and plat washer⑫ to attach plastic belt ⑭ to back panel (G),tighten screw with screwdrive⑩.

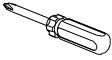
1#	x1	12	x1	15	x1	16	x1	10	x1
									
Safety Strap Kit									

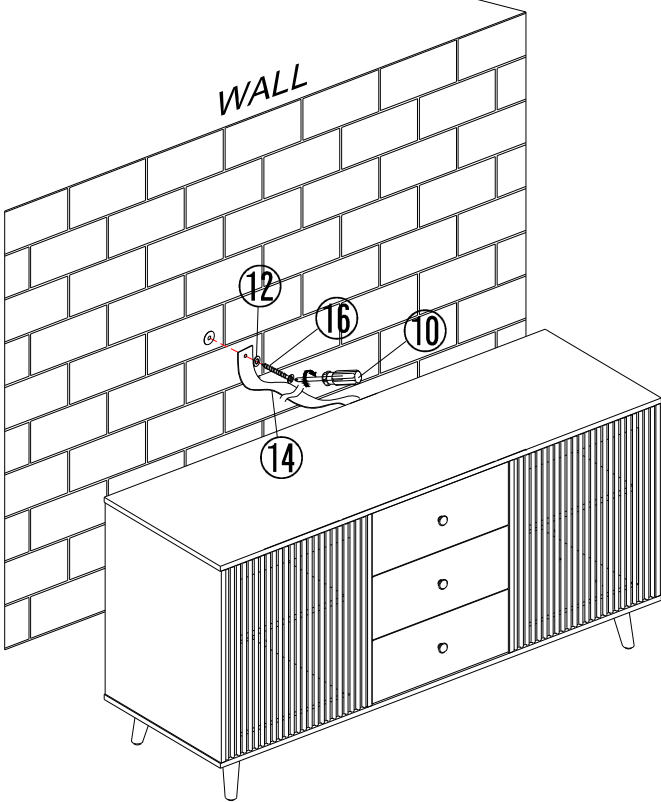

NOT PROVIDED

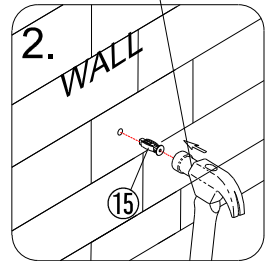
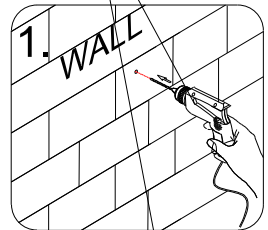

## STEP16:

Install the anti-collapse device.

1. Mark the position on the wall, that corresponds to the location of plastic belt 14 on the back of panel G; Drill and insert the expandable screw 15 by hammer.
2. Assemble the plastic belt 14 to the wall. Align the hole in the plastic belt 14 with the expandable screw 15, use bolt 16 to attach them and tighten by screwdriver 10.

# WARRANTY

We strive to offer high-quality products, and we also try our best to satisfy each and every customer that orders from us with product or service as needed. We provide 30 days warranty starting from the time you receive the item. Each customer must provide a record of their order such as the order number, or item receipt for any items that are out of the warranty period you may also still receive replacement parts by purchasing them with our company if they are available.

Are you having difficulty  
with assembly? Missing parts?  
Please send email with your order No to  
[customerservice@hulalahome.com](mailto:customerservice@hulalahome.com)  
For return, please check the return policy with  
the retailer or market place you bought from.

Appreciate your purchasing from us.  
Pop up your life by our furniture piece!